

User and Reference Manual



Copyright © 1998–2012, Altova GmbH. All rights reserved. Use of this software is governed by and subject to an Altova software license agreement. XMLSpy, MapForce, StyleVision, SemanticWorks, SchemaAgent, UModel, DatabaseSpy, DiffDog, Authentic, AltovaXML, MissionKit, and ALTOVA as well as their logos are trademarks and/or registered trademarks of Altova GmbH. Protected by US Patent 7,739,292.



XML, XSL, XHTML, and W3C are trademarks (registered in numerous countries) of the World Wide Web Consortium; marks of the W3C are registered and held by its host institutions, MIT, INRIA, and Keio. UNICODE and the Unicode Logo are trademarks of Unicode Inc. This software contains 3rd party software or material that is protected by copyright and subject to other terms and conditions as detailed on the Altova website at http://www.altova.com/legal_3rdparty.html

Altova SchemaAgent 2012 User & Reference Manual

All rights reserved. No parts of this work may be reproduced in any form or by any means - graphic, electronic, or mechanical, including photocopying, recording, taping, or information storage and retrieval systems - without the written permission of the publisher.

Products that are referred to in this document may be either trademarks and/or registered trademarks of the respective owners. The publisher and the author make no claim to these trademarks.

While every precaution has been taken in the preparation of this document, the publisher and the author assume no responsibility for errors or omissions, or for damages resulting from the use of information contained in this document or from the use of programs and source code that may accompany it. In no event shall the publisher and the author be liable for any loss of profit or any other commercial damage caused or alleged to have been caused directly or indirectly by this document.

Published: 2012

© 2012 Altova GmbH

Table of Contents

1	SchemaAgent 2012	3
2	About this Documentation	6
3	Introduction	8
3.1	SchemaAgent's Main Features	10
3.2	Configuring Search Paths	12
3.2.1	Adding or Editing Search Paths.....	13
3.2.2	Configuring File Extensions.....	15
3.2.3	Reloading or Resetting Search Paths.....	16
3.2.4	Viewing the Configuration File.....	17
4	SchemaAgent Tutorial	20
4.1	Setting Up SchemaAgent Client	21
4.1.1	Connecting to the LocalServer.....	21
4.1.2	Configuring a Search Path to the Examples Folder.....	22
4.2	Creating Relationships Between XML Schemas	25
4.2.1	Creating an Include Relationship.....	25
4.2.2	Creating a Redefine Relationship.....	26
4.2.3	Creating an Import Relationship.....	27
4.3	Using XMLSpy as a SchemaAgent Client	29
4.3.1	Connecting XMLSpy to the LocalServer.....	29
4.3.2	Making Elements into Global Complex Types.....	30
4.3.3	Including Types.....	30
4.3.4	Redefining Types.....	32
4.3.5	Using Redefined Types.....	35
4.3.6	Importing Types.....	37
4.3.7	Including Types Using Only XMLSpy.....	39
4.4	Viewing the Updated Relationships	42
4.5	Viewing MapForce Design (MFD) Files	44

5 SchemaAgent Server 48

5.1	Installing SchemaAgent Server	49
5.1.1	Standalone Server.....	50
5.1.2	Interactive Service.....	51
5.1.3	Non-Interactive Service.....	51
5.2	Starting SchemaAgent Server	53
5.3	Hiding and Exiting SchemaAgent Server	54
5.4	The SchemaAgent Server User Interface	55
5.4.1	Environment Window	55
5.4.2	Log Window	56
5.5	Configuring the SchemaAgent Server GUI	58
5.6	User Reference	60
5.6.1	File Menu	60
5.6.2	View Menu	60
5.6.3	Settings Menu.....	60
5.6.4	Help Menu	60
	<i>Table of Contents</i>	61
	<i>Index</i>	61
	<i>Search</i>	61
	<i>Support Center</i>	61
	<i>FAQ on the Web</i>	61
	<i>SchemaAgent Server on the Internet</i>	62
	<i>About SchemaAgent Server</i>	62

6 SchemaAgent Client 64

6.1	Installing SchemaAgent Client	65
6.2	Starting SchemaAgent Client	66
6.3	The SchemaAgent Client User Interface	67
6.3.1	Explorer Window	67
6.3.2	Overview Window.....	69
6.3.3	Design Window.....	69
6.3.4	Menu Bar, Toolbars, and Status Bar.....	70
6.3.5	Arranging the Information Windows.....	71
6.4	Connecting to a Server	73
6.4.1	Working Locally.....	73
6.4.2	Connecting to a Network Server.....	74
6.5	Working with the Explorer	75

6.5.1	Creating Files and Folders.....	76
6.5.2	Renaming Files and Folders.....	78
6.5.3	Deleting Files and Folders.....	78
6.5.4	Editing Files	79
6.6	Viewing Files in the Design Window	80
6.6.1	Creating and Saving Designs.....	82
6.6.2	Inserting Files and Folders.....	82
6.6.3	Inserting Related Files.....	84
	<i>Directly Related Files</i>	84
	<i>Indirectly Related Files</i>	85
	<i>Linked Files</i>	86
6.6.4	Arranging Files in Designs.....	87
6.6.5	Viewing Schemas.....	88
6.6.6	Viewing XML instance files.....	89
6.6.7	Viewing XSL/XSLT stylesheets.....	90
6.6.8	Viewing WSDL files.....	91
6.6.9	Displaying Relations	93
	<i>Schema Relationships</i>	96
	<i>XML Instances</i>	96
	<i>Stylesheet Relationships</i>	97
	<i>WSDL Relationships</i>	98
	<i>MapForce Design Relationships</i>	99
6.6.10	Showing Related Components	101
6.6.11	Viewing MFD Files.....	103
6.6.12	Displaying Quick Information.....	105
6.7	Working with Designs	110
6.7.1	Selecting Files.....	110
6.7.2	Removing Files.....	112
6.7.3	Ghost Schemas and Incorrect Paths	112
	<i>Correcting Reference Paths</i>	114
	<i>Recreating Ghost Files and XML Instances</i>	116
6.7.4	Reloading Files.....	116
6.7.5	Design Options.....	116
	<i>Aligning Files in Designs</i>	120
	<i>Sorting Files in Designs</i>	124
6.7.6	Connector Options.....	124
6.7.7	Printing Designs	125
6.7.8	Exporting Designs as Images.....	127
6.8	Designing IIR Relationships	128
6.8.1	Creating IIR Relations.....	128

6.8.2	Moving IIR Relationships.....	129
6.8.3	Deleting IIR Relationships.....	129
6.9	User Reference	131
6.9.1	File Menu	131
	<i>New</i>	131
	<i>Open...</i>	131
	<i>Close</i>	132
	<i>Save</i>	132
	<i>Save As...</i>	132
	<i>Export to image...</i>	132
	<i>Print...</i>	132
	<i>Print Preview</i>	132
	<i>Print Setup</i>	132
	<i>Most Recently Used Files</i>	132
	<i>Exit</i>	132
6.9.2	Edit Menu	132
	<i>Cut</i>	133
	<i>Copy</i>	133
	<i>Paste</i>	133
	<i>Delete</i>	133
	<i>Recreate</i>	133
	<i>Synchronize Selection</i>	133
	<i>Select</i>	134
6.9.3	View Menu	135
	<i>Toolbars</i>	135
	<i>Status Bar</i>	135
6.9.4	Layout Menu.....	136
	<i>Show Grid</i>	136
	<i>Align on Grid</i>	136
	<i>Zoom</i>	136
	<i>Layout</i>	137
	<i>Align Edges</i>	138
	<i>Line Up</i>	139
	<i>Order</i>	139
	<i>Resize</i>	139
	<i>Space Evenly</i>	140
	<i>Sort</i>	140
6.9.5	Extras Menu.....	141
	<i>Connect to Server</i>	141
	<i>Reload Search Paths</i>	141
	<i>Correct Reference Paths</i>	142

	<i>Correct All Reference Paths</i>	142
6.9.6	Tools Menu	143
	<i>Customize</i>	143
Commands.....	143
Toolbars.....	144
Tools.....	146
Keyboard.....	147
Menu.....	149
Options.....	151
	<i>Options</i>	152
Design.....	152
Fonts.....	154
Colors.....	155
Relations.....	156
Miscellaneous.....	157
6.9.7	Window Menu.....	157
	<i>Cascade</i>	158
	<i>Tile Horizontally</i>	158
	<i>Tile Vertically</i>	158
	<i>Currently Open Window List</i>	158
6.9.8	Help Menu	158
	<i>Table of Contents</i>	159
	<i>Index</i>	159
	<i>Search</i>	159
	<i>Software Activation</i>	159
	<i>Registration</i>	160
	<i>Check for Updates</i>	160
	<i>Support Center</i>	160
	<i>FAQ on the Web</i>	160
	<i>Download Components and Free Tools</i>	160
	<i>SchemaAgent on the Internet</i>	160
	<i>About SchemaAgent</i>	161

7 XMLSpy and SchemaAgent 164

8 License Information 166

8.1	Electronic Software Distribution	167
8.2	Software Activation and License Metering	168
8.3	Intellectual Property Rights	169
8.4	Altova End User License Agreement	170

Chapter 1

SchemaAgent 2012

1 SchemaAgent 2012

SchemaAgent® 2012 is an Altova technology that enables you to manage multiple schemas and build relationships between W3C XML schemas from within a GUI. SchemaAgent also provides a display of relationships between Altova MapForce design (MFD) files and their associated schemas as well as XSL or XSLT stylesheets and WSDL files. SchemaAgent is available in 64-bit and 32-bit versions.

Altova's SchemaAgent technology consists of two components:

- A [SchemaAgent](#) server serves supported files to one or more SchemaAgent Clients on the network. The server can be installed as a local server together with SchemaAgent Client, as an independent Altova SchemaAgent Server installation, or run as a service.
- The [SchemaAgent Client](#) is an application with a GUI that provides access to the files served by a SchemaAgent server. Using standard GUI mechanisms, such as copy-and-paste and drag-and-drop, SchemaAgent Client users are able to easily build relationships between the served files and to make large-scale changes—such as in path references—across multiple files.



Copyright © 1998–2012, Altova GmbH. All rights reserved. Use of this software is governed by and subject to an Altova software license agreement. XMLSpy, MapForce, StyleVision, SemanticWorks, SchemaAgent, UModel, DatabaseSpy, DiffDog, Authentic, AltovaXML, MissionKit, and ALTOVA as well as their logos are trademarks and/or registered trademarks of Altova GmbH. Protected by US Patent 7,739,292.

XML, XSL, XHTML, and W3C are trademarks (registered in numerous countries) of the World Wide Web Consortium; marks of the W3C are registered and held by its host institutions, MIT, INRIA, and Keio. UNICODE and the Unicode Logo are trademarks of Unicode Inc. This software contains 3rd party software or material that is protected by copyright and subject to other terms and conditions as detailed on the Altova website at http://www.altova.com/legal_3rdparty.html

Chapter 2

About this Documentation

2 About this Documentation

This document provides an overview of how SchemaAgent technology works, and describes how to use the SchemaAgent server and SchemaAgent Client together. It also provides an overview of how Altova's XMLSpy application (Enterprise and Professional Editions) can utilize SchemaAgent technology to provide powerful schema editing and management capabilities.

This document is divided into the following parts:

- An [introduction](#) to SchemaAgent and its mechanism.
- An overview of SchemaAgent's [main features](#).
- A description of how to [configure the search paths](#) for SchemaAgent.
- A SchemaAgent [tutorial](#).
- A description of the installation, configuration, and use of [SchemaAgent Server](#) .
- A description of the installation, configuration, and use of [SchemaAgent Client](#).
- An overview of how to use [XMLSpy](#) Enterprise and Professional Editions as SchemaAgent clients.

Chapter 3

Introduction

3 Introduction

Altova's SchemaAgent technology consists of two components: a SchemaAgent server and SchemaAgent Client. A SchemaAgent server is installed either

- on the same machine as SchemaAgent Client, where it serves that particular client (the **LocalServer** version, installed with SchemaAgent Client); or
- on a network, from where it can serve multiple clients (**SchemaAgent Server**, separate installation from SchemaAgent Client).

SchemaAgent technology can also be used in Altova's **XMLSpy® 2012** product (Enterprise and Professional Editions). XMLSpy communicates via SchemaAgent Client with either LocalServer or SchemaAgent Server.

SchemaAgent in the Altova product range

Both SchemaAgent Server and SchemaAgent Client are to be downloaded separately from the [SchemaAgent download page](#) at the Altova website and installed separately. SchemaAgent Server is available free of charge, whereas SchemaAgent Client requires a license that must be purchased from Altova.

The Altova® MissionKit™ 2012 includes the SchemaAgent product and a license key for it. The SchemaAgent Server application, however, is not included as part of the Altova® MissionKit™ 2012 packages, and must be downloaded from the [SchemaAgent download page](#) at the Altova website.

In order to use SchemaAgent with XMLSpy, SchemaAgent Client must be installed on the same machine as XMLSpy. SchemaAgent Server can be installed anywhere on the network. Once SchemaAgent Server and SchemaAgent Client are correctly installed, XMLSpy will automatically make the necessary associations. XMLSpy Enterprise Edition and XMLSpy Professional Edition (when purchased independently of Altova® MissionKit™ 2012 applications) can both use SchemaAgent.

Important: Any SchemaAgent or SchemaAgent-related product from Altova (including XMLSpy) starting with Version 2005 release 3 is **not compatible** with versions of SchemaAgent or SchemaAgent-related products previous to it.

File Paths in Windows XP, Windows Vista, and Windows 7

File paths given in this documentation will not be the same for all operating systems. You should note the following correspondences:

- *(My) Documents folder:* The My Documents folder of Windows XP is the Documents folder of Windows Vista and Windows 7. It is located by default at the following respective locations. Example files are usually located in a sub-folder of the (My) Documents folder.

Windows XP	C: /Documents and Settings/<username>/My Documents
Windows Vista, Windows 7	C: /Users/<username>/Documents

- *Application folder:* The Application folder is the folder where your Altova application is located. The path to the Application folder is, by default, the following.

Windows XP	C: /Program Files/Altova
------------	--------------------------

Windows Vista, Windows 7	C:/Program Files/Altova
32-bit Version on 64-bit OS	C:/Program Files (x86)/Altova

- *Application Data folder:* The Application Data folder of Windows XP is the AppData folder of Windows Vista and Windows 7. This folder contains the configuration file for SchemaAgent Server. The path to the Application data, respectively AppData, folder is, by default, the following.

Windows XP	C:/Documents and Settings/All Users/Application Data
Windows Vista, Windows 7	C:/Users/All Users/AppData

3.1 SchemaAgent's Main Features

SchemaAgent Server processes client requests to create, update, or delete schema IIRs (Includes, Imports, and Redefines) and manages client-server communication. It also processes all file-based manipulations: create, delete, move, and rename.

Installation options

SchemaAgent Server can be installed as a standalone application with a GUI, or as an interactive or non-interactive service.

Graphical user interface

SchemaAgent Server's graphical user interface (GUI) provides full environment information, including lists of currently connected clients and all defined search paths. An Environment window displays all defined search paths as hierarchical tree structures as well as all file extensions defined for schemas, MFD, XML, XSL/XSLT, and WSDL files, and provides easy-to-use search path selection using Explorer-type browse functionality. The main window in the right area of SchemaAgent Server displays all files with the defined file extensions that have been found in the search paths.

Logging functionality

The user interface provides a Log window that displays detailed communications activity. The log reports can be configured and written to CSV files.

Access to schemas on the web

SchemaAgent Server enables access to schemas located in WebDAV folders on (secure) WebDAV servers with UNC paths and drive letters.

SchemaAgent Client provides a GUI that enables you to build schema relationships and manage large numbers of schemas, as well as view relationships between MFD files and their associated schemas. These are the core features of SchemaAgent technology. In addition, SchemaAgent Client provides user-friendly GUI features.

SchemaAgent designs

Schema designs help you to manage and organize schema collections intuitively. These designs can be saved as SchemaAgent design files for subsequent editing. You can create, update, or delete IIRs (Includes, Imports, and Redefines) between schemas by direct manipulation in a SchemaAgent design using drag-and-drop. Once an IIR relationship is created or modified in a SchemaAgent design, that relationship is physically written into the relevant schema (XSD) file(s) and any related schema file. To undo a modification to a relationship, you must edit the SchemaAgent design accordingly.

For XSLT stylesheets, SchemaAgent Client allows you to create imports and includes as well as import schemas or create new or display existing inline schemas.

The Design window also shows WSDL files where you can explore the content of the WSDL file and view its internal schemas as well as all of its messages, port types, bindings, and services. The import of XML schemas or different WSDL files is also possible.

File administration

If a file is renamed or moved, the change is passed to all other files in the workspace that reference the changed file. The advantage is that multiple files can be managed from within the SchemaAgent Client GUI, thus obviating the need to edit individual files separately.

Viewing structures and relations

In the Design window, you can obtain a graphical view of the relationships between an MFD file, its source and target schemas, and all schemas associated with the source and target

schemas. IIRs can be viewed immediately and in greater detail in the schema component itself and the detailed structure of schema components, such as elements and complex types, can be displayed.

This applies also to XML instances, XSLT stylesheets and WSDL files. For each of these files, SchemaAgent Client displays a file box in the Design window. These file boxes contain all the relevant information for a particular file, structured in collapsed sections which can be expanded to view some of the data in detail.

Selecting or inserting related files

SchemaAgent Client offers several options to select file boxes or insert files that reference other files in the workspace.

Integration with XMLSpy

If set up to work with SchemaAgent, Altova's XMLSpy provides powerful schema editing capabilities. While a schema is being edited in the Schema/WSDL View of XMLSpy, components of all schemas in SchemaAgent Server's search paths are listed in the Entry Helpers and can be modified and reused in the schema being edited. Information about IIRs created or modified in Schema/WSDL View is written to related schemas.

System requirements

Altova SchemaAgent Client and SchemaAgent Server run on Windows XP, and Windows Vista and Windows 7.

3.2 Configuring Search Paths

Search paths are the paths or folders that are scanned for XML Schemas, MapForce Design (MFD) files, and XML files. Depending on your SchemaAgent installation, you can configure (i.e., add, edit, or delete) search paths in the Configure Paths tab of either SchemaAgent Client or SchemaAgent Server.

If you are working with a **LocalServer**, the Configure Paths tab is displayed as an additional tab in the Explorer window of the SchemaAgent Client application.

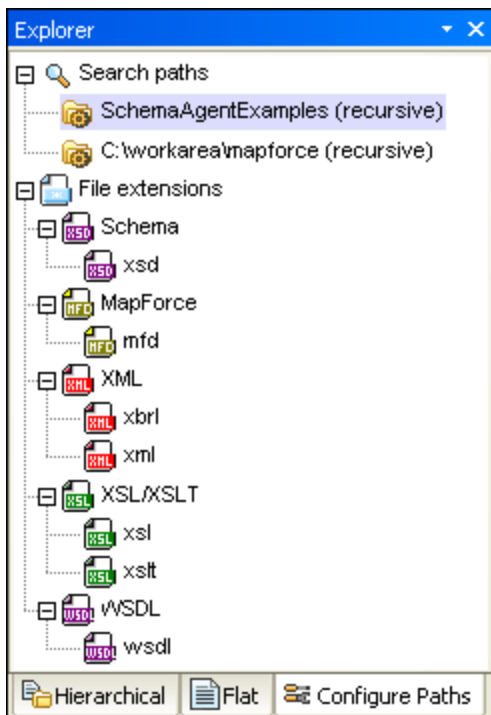

If you have installed a **SchemaAgent Server** locally or in a network, the Configure Paths tab is displayed in the Environment window of SchemaAgent Server. The Explorer window in SchemaAgent Client has no Configure Paths tab if you are connected to SchemaAgent Server.

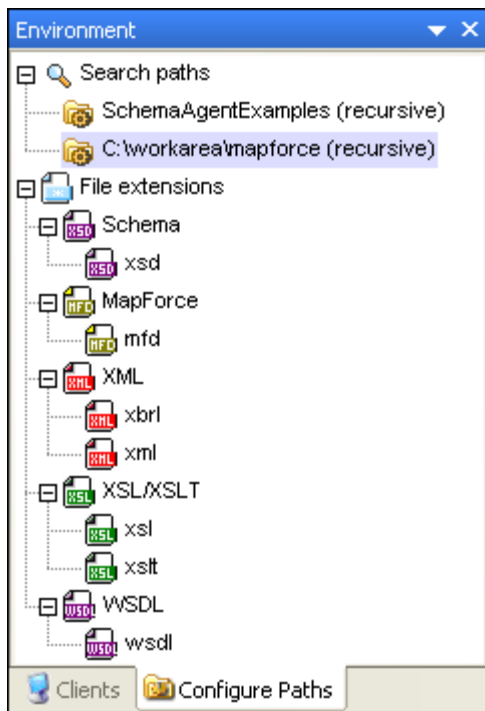

Apart from its location, the Configure Paths tab is identical in both of the above mentioned cases.

Search Path considerations

Depending on the installation location of SchemaAgent, certain file access and path restrictions may apply. If you access schemas on a network share, make sure that the SchemaAgent application has the correct access permissions.

File system support is as follows:

- UNC paths are supported. Note that schema paths can be, or references within schemas can contain, UNC paths or relative paths.
- WebDAV folders are supported. Location paths can be, or references within schemas can contain, WebDAV folders or relative paths.
- FTP connections are supported. Files can be directly accessed using FTP.
- Mapped drives are supported. If drive letters are used in search paths, then machines hosting SchemaAgent clients must have the identical drive letter mapped to the same shared folder.
- Local drives/directories are **not directly** supported. Access to local directories or resources, however, is possible if the local directories are shared to the network and search paths on LocalServer are configured to use the network shares.

3.2.1 Adding or Editing Search Paths

In order to be able to work with a file in SchemaAgent Client, it must be contained in one of the search paths that are displayed in the Hierarchical and Flat tabs of the Explorer window. You cannot open files from outside SchemaAgent Client or drag them into the Design window.

Please note: The procedure described below applies to the Configure Paths tab in both the Explorer window in SchemaAgent Client and the Environment window in SchemaAgent Server. The type of your SchemaAgent installation and the server you are connected to, respectively, determines in which window the Configure Paths tab is displayed.

Relative paths

In SchemaAgent, you can define to display search paths relative to location the [configuration file](#). This allows you to have shorter search path, if your folder structure is very extensive. Please note, that with SchemaAgent LocalServer each user has a separate configuration file in [\(My Documents\)\Altova\SchemaAgent LocalServer2012](#).

To add or edit a search path:

- In the Configure Paths tab of your respective SchemaAgent application, do one of the following:
 - To add a search path, right-click the `Search paths` folder and select **Add search path** from the context menu, or click the folder and press the **Insert** key.
 - To edit a search path, right-click one of the existing search paths and select **Edit search path** from the context menu.

The **Add/Edit search path** dialog box opens.

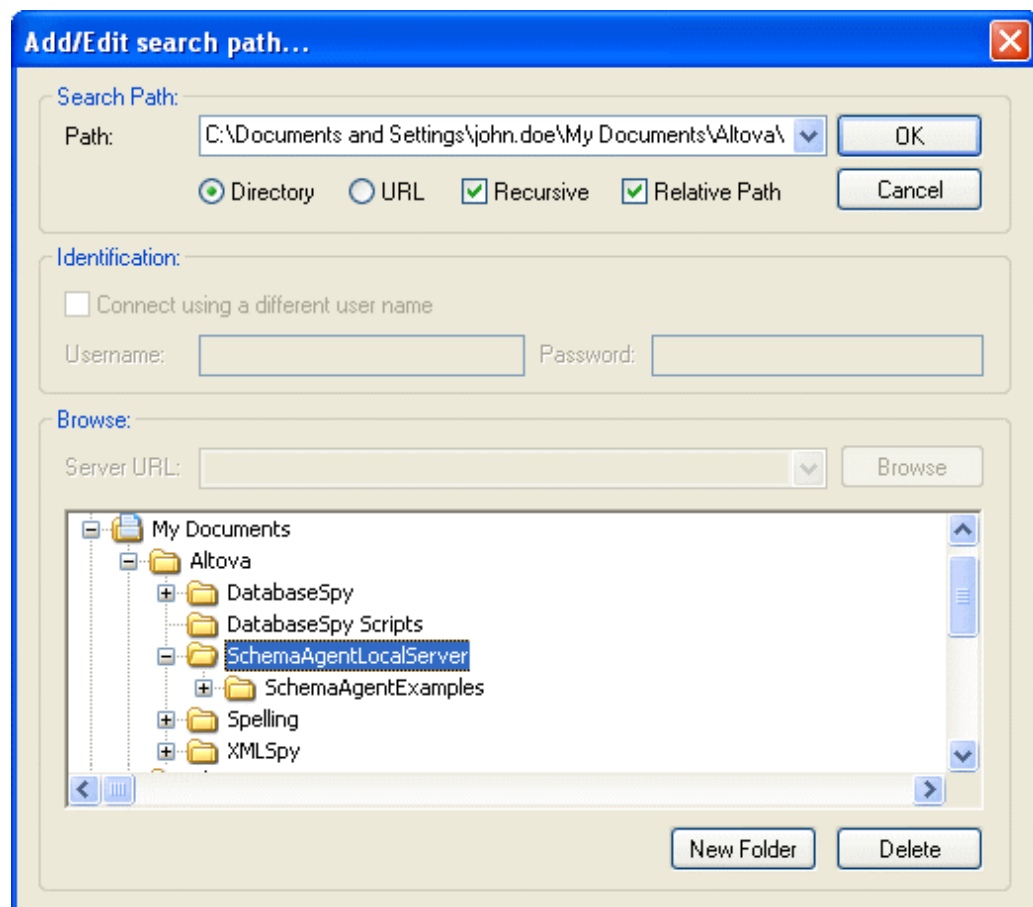

- In the Search Path group box, choose whether the search path is a directory or a URL. If the search path is a directory, do the following:
 - Select the `Directory` radio button and enter the search path directly in the `Path` text box. Alternatively, browse for the required directory in the `Browse` pane; the selected directory is entered in the `Path` text box.
 - Select the `Relative Path` check box to make the search path entry in the

Configure Paths pane relative; leave the check box unchecked to use an absolute path.

If the search path is a URL, do the following:

1. Enter the server URL in the Server URL text box of the Browse pane.
2. If authorization is required, in the Identification group box, select the `Connect using a different user name` check box and enter the username and password.
3. In the Browse group box, click the **Browse** button to browse for the required directory; the selected directory is entered in the `Path` text box in the Search Path group box.
3. Select the `Recursive` check box if you wish sub-directories of the selected directory to be searched. If this check box is not selected, no sub-directories will be searched.
4. Click **OK**.

To delete a search path:

1. In the Configure Paths tab of your respective SchemaAgent application, select the path you want to delete and do one of the following:
 - Right-click and choose **Delete search path** from the context menu.
 - Press the **Delete** key.
2. Click **Yes** in the message box that pops up.

3.2.2 Configuring File Extensions

By default, SchemaAgent Client displays the following file types in the Hierarchical and Flat tabs of the Explorer window:

- W3C XML Schema
- MapForce Design files
- XML files
- XSL and XSLT stylesheets
- Web Service Description Language (WSDL) files

The `File extensions` folder in the Configure Paths tab, therefore, has five sub-folders, `Schema`, `MapForce`, `XML`, `XSL/XSLT`, and `WSDL`. Three of these folders include a single entry—`xsd`, `mfd`, or `wsdl`, respectively— whereas in the `XSL/XSLT` and `XML` folders two entries—`xsl` and `xslt`, and `xbrl` and `xml`, respectively—are displayed. You can, however, define additional file extensions for any of the supported files.

To add a file extension:

1. In the Configure Paths tab of your respective SchemaAgent application, select a folder or a file extension under the `File extensions` folder and do one of the following:
 - Right-click and choose **Add file extension** from the context menu.
 - Press the **Insert** key.
2. An entry named "newextension" is added to the respective folder and selected for editing.

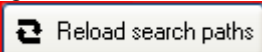
The  button appears flashing red.

3. Enter the desired file extension and press **Enter**.
4. Click the **Reload search paths** button to display files with the newly added file

extension in the Explorer window.

To edit a file extension:

1. In the Configure Paths tab of your respective SchemaAgent application, select a file extension under one of the sub-folders of the `File extensions` folder and do one of the following:

- Right-click and choose **Edit file extension** from the context menu.
- Press **F2**.

The file extension name is selected for editing.

2. Edit the file extension name as required and press **Enter**.

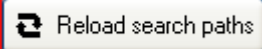
The  button appears flashing red.

3. Click the **Reload search paths** button to display files with the changed file extension in the Explorer window.

To delete a file extension:

1. In the Configure Paths tab of your respective SchemaAgent application, select a file extension under one of the sub-folders of the `File extensions` folder and do one of the following:

- Right-click and choose **Delete file extension** from the context menu.
- Press **Delete**.

2. Click **Yes** in the message box that pops up.

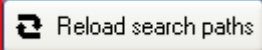
The  button appears flashing red.

3. Click the **Reload search paths** button to remove files with the deleted file extension from the Explorer window.

3.2.3 Reloading or Resetting Search Paths

The **Reload search paths** command updates the search paths. This may be useful if files have been changed outside SchemaAgent, for example in XMLSpy, or if the search path configuration has changed. After a search path or file extension has been added, edited, or deleted, an asterisk appears at the right of that search path or file extension and the

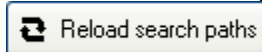

button is displayed at the bottom of the Configure Paths tab. This indicates that the currently loaded search paths need to be updated.

The **Reset Search Paths** command resets search paths to the settings with which they were last saved.

To reload search paths:

Do one of the following:

- In the Configure Paths tab of your respective SchemaAgent application, right-click and select **Reload search paths** from the context menu.
- Select the menu option **Extras | Reload search paths**.
- Click the **Reload search paths**  icon in the Extras toolbar.

To reset search paths:

- In the Configure Paths tab of your respective SchemaAgent application, right-click and select **Reset search paths** from the context menu.

3.2.4 Viewing the Configuration File

The set of supported files managed by LocalServer or SchemaAgent Server, respectively, is defined in an XML file called `SchemaAgentServerCfg.xml`, which—depending on whether you use SchemaAgent LocalServer or SchemaAgent Server—is by default stored in the following folders:

- **SchemaAgent LocalServer:** ...\[\(My Documents\)](#)\Altova\SchemaAgent LocalServer2012
- **SchemaAgent Server:** ...\[Application Data](#)\Altova\SchemaAgentServer2012

This file defines the **search paths**, and what paths or folders are scanned for schema files. The `SchemaAgentServerCfg.xml` file looks something like this:

```
<?xml version="1.0" encoding="UTF-8"?>
<SearchPaths XMLSchema=".xsd" MapForce=".mfd" XML=".xbrl,.xml"
XSL=".xsl,.xslt" WSDL=".wsdl">
  <Path recursive="1" user="" auth="000000">s:\schemas-mydir\</Path>
  <Path recursive="0" user="" auth="000000">X:\schemas\</Path>
  <Path recursive="1" user="" auth="000000">http://test.webdav.org/dav</Path>
  <Path recursive="1" user="" auth="000000">\\Server1\Share1\Dir1\Schemadata</Path>
  <Path recursive="1" user="jsmith" auth="k04EKS">ftp://myftpserver</Path>
</SearchPaths>
```

Note that any number of search paths can be defined, and search paths can include paths on a local machine, network paths (mapped drive letters and UNC paths), as well as folders on WebDAV servers and FTP access.

After search paths have been defined, LocalServer or SchemaAgent Server, respectively, retrieves all files with defined file extensions in individual search paths and builds an internal map of the relationships between the supported files in a search path. It is this mapping of relationships that enables SchemaAgent clients to present data about file relationships graphically. Further, if an IIR or file manipulation change is made in a SchemaAgent client, it is this mapping that enables the automatic updating of such changes in related files in the search path.

Chapter 4

SchemaAgent Tutorial

4 SchemaAgent Tutorial

This tutorial gives a short overview of W3C XML schemas and takes you through several tasks which provide an overview of how to use SchemaAgent to its fullest.

You will learn how to:

- [Set up](#) SchemaAgent Client properly
- **Create** [Include](#), [Import](#), and [Redefine](#) relationships between XML schemas
- [Include](#), [redefine](#), and [import](#) a **type**
- Import a type [using only XMLSpy](#)
- View [updated relationships](#)
- View [MapForce design](#) (MFD) files

Installation and configuration

This tutorial assumes that you have successfully installed SchemaAgent on your computer and received a free evaluation key-code, or are a registered user. The evaluation version of SchemaAgent is fully functional but limited to a 30-day period. You can request a regular license from our secure web server or through any one of our resellers.

Tutorial example files

The tutorial files are available in the [\My Documents\Altova\SchemaAgent LocalServer2012\SchemaAgentExamples\Tutorial](#) folder. The Examples folder contains various XML schemas for you to experiment with, while the Tutorial folder contains all the files used in this tutorial. For each user account that is defined on your computer, a separate SchemaAgentExamples folder as well as a [configuration file](#) will be created when the user logs on. This allows for each user to store his or her own search paths and have his or her own example files.

4.1 Setting Up SchemaAgent Client

In this tutorial, we will work with the LocalServer that is automatically installed with SchemaAgent Client. You must connect SchemaAgent Client to the LocalServer before you can use it to create relationships between XML schemas.

In order to work with SchemaAgent, you must configure at least one path to a folder. Paths you configure are stored on the SchemaAgent server (in this case, the LocalServer). Using SchemaAgent Client, you create relationships between existing schemas in these paths. You can also create new skeleton XML schemas, which can be completed later using XMLSpy.

Objective

In this section of the tutorial, you will learn how to connect to a server and define a search path. Specifically, you will learn how to do the following:

- Start SchemaAgent Client and [connect](#) to the LocalServer
- [Configure a search path](#) to the folder that contains the examples for this tutorial

Commands used in this section

In this section of the tutorial, you will use the Explorer window exclusively. The following commands are used:



Connect to Server: This icon is located in the Extras toolbar. Click this icon to open the **Connect to SchemaAgent Server** dialog box where you can choose a server to connect to.

Add search path: This command is included in the context menu that opens when you right-click anywhere in the Configure Paths tab of the Explorer window. Choose this command to add a new search path to the current SchemaAgent server.

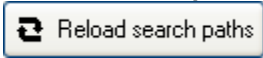

Reload search paths: This icon is located in the Extras toolbar and also appears as a  button at the bottom of the Explorer window after changes occurred in the search paths.

4.1.1 Connecting to the LocalServer

When you install SchemaAgent Client, both the client and the LocalServer are installed. The connection to the LocalServer is established during the startup process of SchemaAgent Client.

Starting SchemaAgent Client

To start SchemaAgent Client, double-click the SchemaAgent icon on your desktop or use the **Start | All Programs** menu to access the SchemaAgent program. SchemaAgent Client is started with no documents open in the interface and the **Connect to SchemaAgent Server** dialog box pops up.

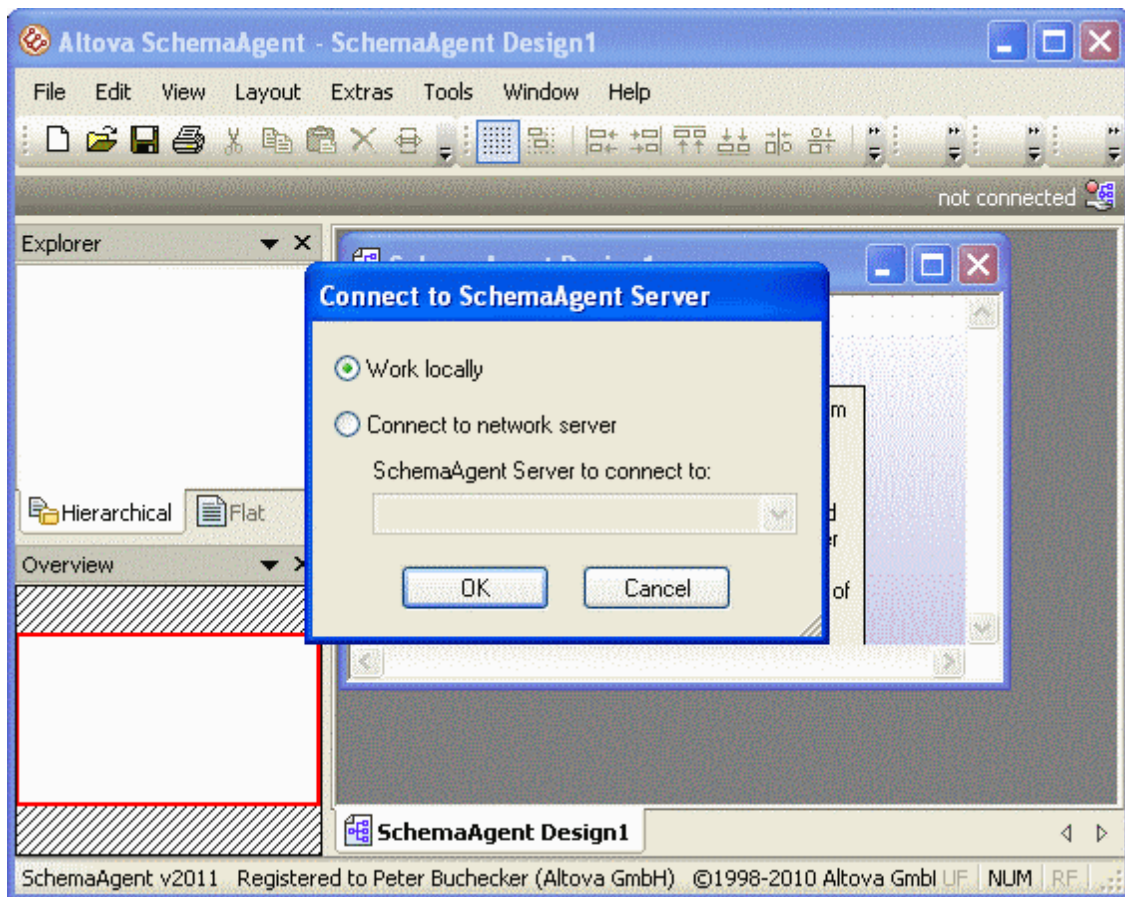

Note the main parts of the interface: the Explorer and Overview windows on the left and the Main window in the middle.

To connect to the LocalServer:

1. Do one of the following:
 - Double-click the SchemaAgent icon on your desktop or use the **Start | All Programs** menu and choose **Altova SchemaAgent 2012 | Altova SchemaAgent**.
 - If SchemaAgent Client is already running, select the menu option **Extras | Connect to server** or choose the **Connect to Server**  icon from the Extras toolbar. The **Connect to SchemaAgent Server** dialog box appears.
2. Choose `Work locally`.
3. Click **OK**.

4.1.2 Configuring a Search Path to the Examples Folder

SchemaAgent Client displays the search paths defined in a SchemaAgent server in the Hierarchical and Flat tabs of the Explorer window. If you edit a schema file using SchemaAgent Client and XMLSpy is currently connected to the SchemaAgent server, XMLSpy prompts you to reload the schema file, if you currently have that file open.

In this section, you will configure a path to the folder that contains the files used in this tutorial.

To configure a search path to the Tutorial folder:

1. In the Explorer window of SchemaAgent Client, click the **Configure Paths** tab.
2. Right-click anywhere in the Explorer window and select **Add search path** from the context menu. Alternatively, select the `Search paths` entry in the Explorer window and press the **Insert** key.
The **Add/Edit search path** dialog box opens.

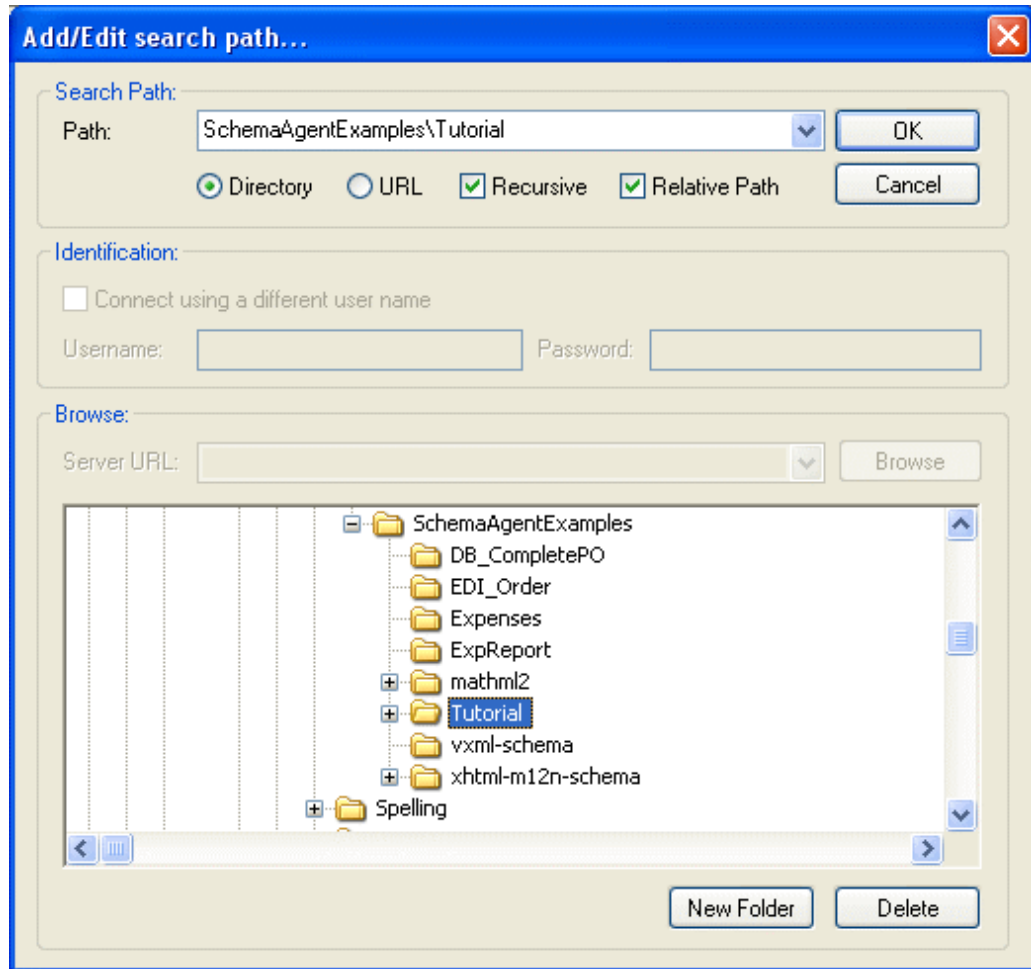

3. In the Search Path group box, select the `Directory` radio button and activate the `Recursive` check box to have the sub-folders displayed as well.
4. In the Browse group box, navigate to the `(My Documents)\Altova\SchemaAgent LocalServer2012\SchemaAgentExamples\Tutorial` sub-folder.
5. Optionally, if your paths are very long, activate the `Relative Path` check box in the Search Path group box.
6. Click **OK**.
The search path appears in the Explorer window.

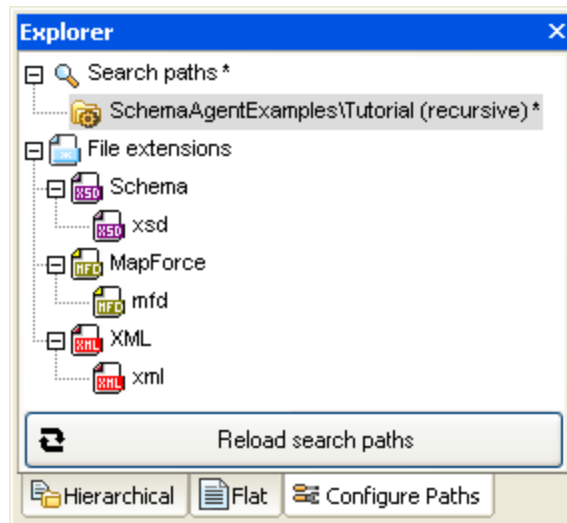

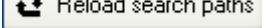
7. Click the  button that appears at the bottom of the Explorer window.

4.2 Creating Relationships Between XML Schemas

In this section, you will use SchemaAgent Client to create [include](#), [redefine](#), and [import](#) relationships between schemas.

Objective

In this section of the tutorial you will learn how to create IIR relationships between schemas. Specifically, you will learn how to do the following:

- [Show schemas](#) in the Design view of SchemaAgent Client
- [Create an include relationship](#) between two schemas
- [Create a redefine relationship](#) between two schemas
- [Create an import relationship](#) between two schemas using different namespaces

Commands used in this section

In this section of the tutorial, you will use the Design window exclusively. The following commands are used:



New (Ctrl+N): This icon is located in the Standard toolbar and it is also available as an option in the **File** menu. Use this command to open a new Design window.

4.2.1 Creating an Include Relationship

In this section you will create an include relationship between the following schemas provided in the `include_redefine` sub-folder of the `SchemaAgentExamples\Tutorial` folder:

- **event_registration.xsd:** This schema is structured to contain information about a participant who registers for a sporting event. Because these events have fees, a type for containing credit card information is also defined in this schema.
- **dvd_order.xsd:** This schema is structured to contain order details for mail order DVDs, and customer shipping details.

In the course of this example, you will create an Include relationship so that `dvd_order.xsd` includes types from `event_registration.xsd`, specifically those that store customer and credit card data.

To display schemas in a Design window:

1. Select the menu option **File | New**, or click the **New**  icon in the Standard toolbar, or press **Ctrl+N** to open a new Design window.
2. In the Explorer window, select `event_registration.xsd` and `dvd_order.xsd` from the `include_redefine` folder and drag them into the Design window.

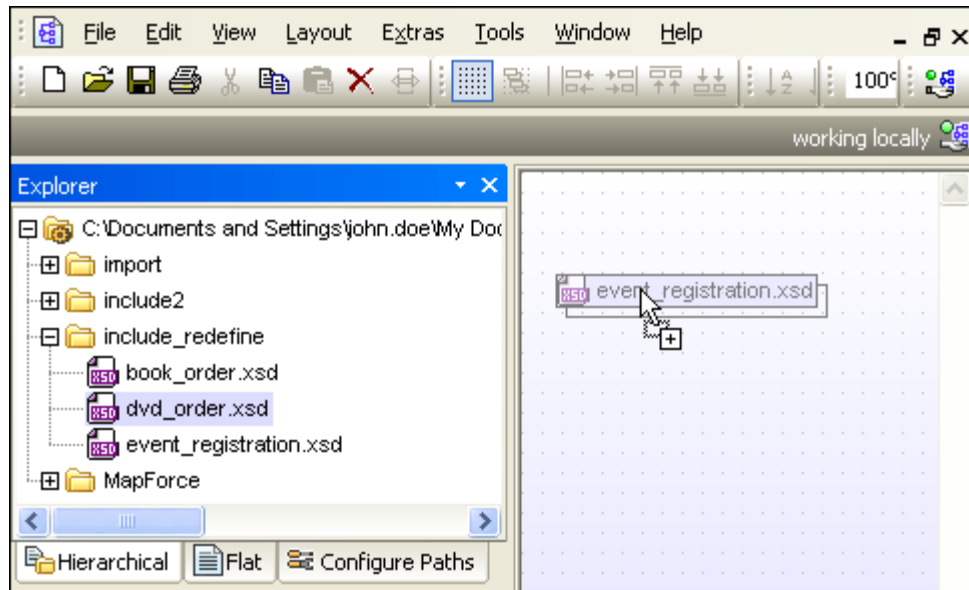

Please note: To drag and drop more than one file at the same time, select the files first by clicking on the files while holding down the **Ctrl** key. Drag and drop a folder to put all the files it contains in the Design window.

To create an include relationship:

1. Click on the small white triangle on the right side of the file box of `event_registration.xsd` and drag the connector line to the file box of `dvd_order.xsd`.

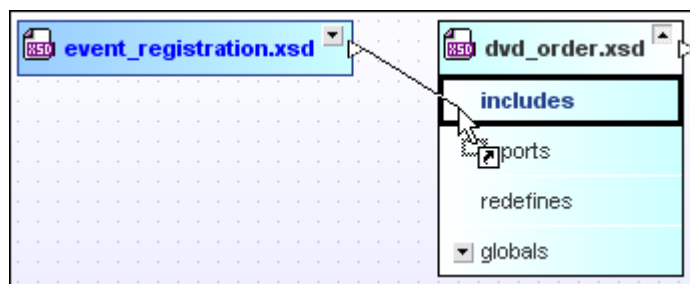

2. Release the mouse button over the word "includes". A green arrow that points from `event_registration.xsd` to `dvd_order.xsd` appears.

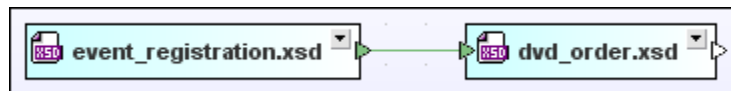

This arrow shows that an include relationship has been made between these schemas.

4.2.2 Creating a Redefine Relationship

In this section, you will create a redefine relationship between the following schemas provided in the `include_redefine` sub-folder of the `SchemaAgentExamples\Tutorial` folder:

- **event_registration.xsd**
- **book_order.xsd:** This schema is structured to contain order details for mail order books.

In the course of this example, you will create a redefine relationship so that `book_order.xsd`

includes and redefines types from `event_registration.xsd`, specifically the types for storing customer and credit card data.

Redefinition of schemas creates an implicit include relationship between the schemas and enables access to all elements in the referenced schema. It allows you to redefine (i.e., restrict or extend) the individual components of the referenced schema.

Please note: In SchemaAgent Client, only the redefine relationship is created between the schemas. The [actual redefinition of individual components](#) can be done in XMLSpy.

To create a redefine relationship:

1. In the Explorer window, select `book_order.xsd` from the `include_redefine` folder and drag it into the Design window that already contains the files `event_registration.xsd` and `dvd_order.xsd`.
2. Click on the small green triangle on the right side of the file box of `event_registration.xsd` and drag the connector line to the file box of `book_order.xsd`.

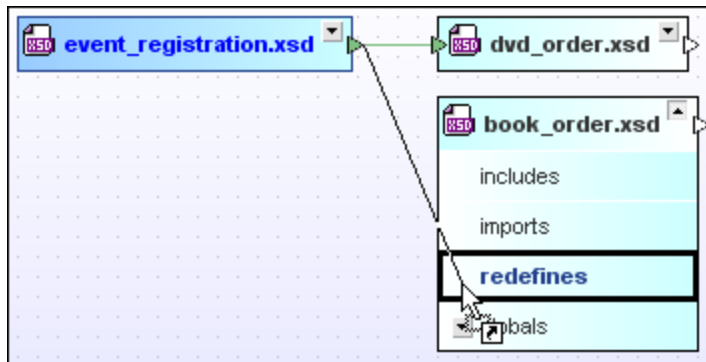

3. Release the mouse button over the word "redefines". A purple arrow that points from `event_registration.xsd` to `book_order.xsd` appears.

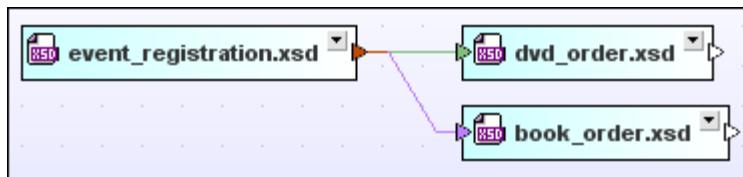

This arrow shows that a redefine relationship has been made between these schemas. Please note that the color of the triangle in the `event_registration.xsd` file box changed to indicate that relationships of different types are existing with this file box.

4.2.3 Creating an Import Relationship

The import relationship is used when you want to reuse components from one schema in a schema with a different namespace. In this section, you will create an import relationship between the following schemas provided in the import sub-folder of the SchemaAgentExamples \Tutorial folder:

- **book_store.xsd:** This schema is structured to contain the address of the book store, and details for each book in the inventory.
- **library.xsd:** This schema is structured to contain the address of the library, and details (card catalog number and whether the book is currently being borrowed) for each book in the library.

In the course of this examples, you will create an import relationship so that `library.xsd`

imports a type containing other book information from `book_store.xsd`.

To create an import relationship:

1. Select the menu option **File | New**, or click the **New**  icon in the Standard toolbar, or press **Ctrl+N** to open a new Design window.
2. In the Explorer window, select `book_store.xsd` and `library.xsd` from the `import` folder and drag them into the new Design window.
3. Click on the small white triangle on the right side of the file box of `book_store.xsd` and drag the connector line to the file box of `library.xsd`.

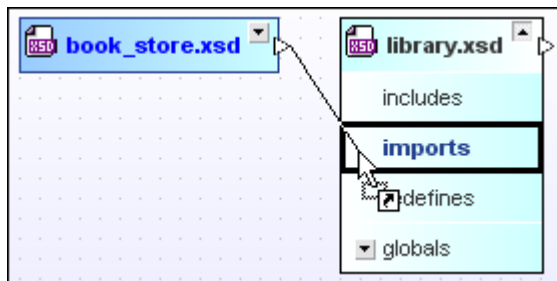

4. Release the mouse button over the word "imports".

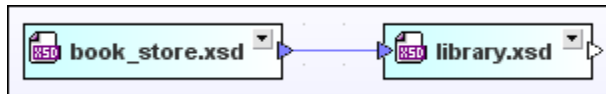

A blue arrow that points from `book_store.xsd` to `library.xsd` appears. This arrow shows that an import relationship has been made between these schemas.

4.3 Using XMLSpy as a SchemaAgent Client

In the previous sections of the tutorial, you have created [include](#), [import](#) and [redefine](#) relationships between schemas. When you create a relationship using SchemaAgent Client, the corresponding include, import or redefine statement is automatically added to the XML schema.

Objective

In this section of this tutorial, you will learn how to use XMLSpy to do the actual including, importing and redefining of individual components of the schemas. Specifically, you will learn how to do the following:

- [Connect XMLSpy](#) to a SchemaAgent server
- Make elements of a content model [into global complex types](#)
- [Include complex types](#) in a different schema
- [Redefine types](#) in XMLSpy
- [Import complex types](#) from schemas using different namespaces
- Include complex types [directly in XMLSpy](#)

Commands used in this section

In this section of the tutorial, you will use the Schema/WSDL View of XMLSpy exclusively. The following commands are used:



Connect to SchemaAgent Server: This icon is located in the Schema design toolbar. Click this icon to open the **Connect to SchemaAgent Server** dialog box where you can choose a server to connect to.



Display Diagram (or Display Content Model View): This icon is located to the left of all global components in Schema Overview. Click this icon to display the content model of the associated global component.

Make Global: This command is included in the context menu that opens when you right-click an element in the Content Model View. Use this command to make this element into a new global element.

Add Child | Element: This command is included in the context menu that opens when you right-click a sequence element in the Content Model View. Use this command to add a new child element to the content model.



Insert: This icon is located at the top left-hand corner of the Schema Overview. Clicking the icon enables you to insert a global component before the selected element.



Display All Globals: This icon is located at the top left-hand corner of the Content Model View. Clicking the icon switches the view to Schema Overview, which displays all global components.

4.3.1 Connecting XMLSpy to the LocalServer

You can connect to the LocalServer either during the starting process of SchemaAgent Client or, later, by using the appropriate menu option or toolbar icon.

To open XMLSpy and connect to the SchemaAgent LocalServer:

1. In SchemaAgent Client, right-click the file box of event_registration.xsd and select **Edit in XMLSpy (Ctrl+Y)** from the context menu.
2. In XMLSpy, select the menu option **Schema design | Connect to SchemaAgent Server** or click the **Connect to SchemaAgent Server**  icon in the Schema design

toolbar.

3. In the **Connect to SchemaAgent Server** dialog box, select the `Work locally` radio button and click **OK**.
4. Click **OK** in the information window that pops up.

4.3.2 Making Elements into Global Complex Types

Creating IIR relationships makes the element of a schema available to other schemas. However, only global elements can be used in other schemas. In this section of the tutorial, you will learn how to use XMLSpy to make an element into a global complex type that can be included in different schemas.

To make elements to be included global:

1. [Open event_registration.xsd in XMLSpy.](#)
2. In XMLSpy, click the **Display Diagram**  icon for the element `event_registration` to display its content model.

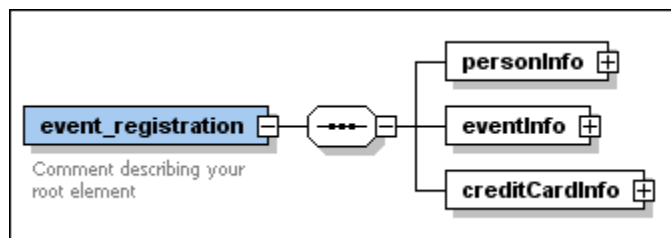

3. Right-click on the `personInfo` element and select **Make Global | Complex type** from the context menu. A new global complex type called `personInfoType` is created.

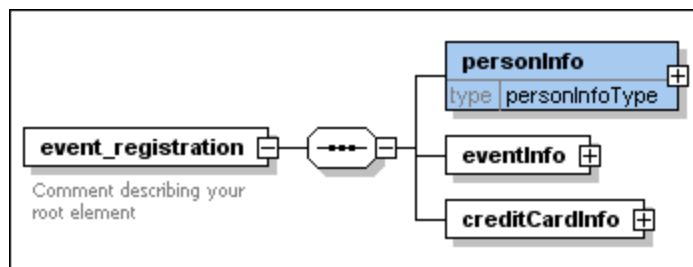

Please note: If "type" does not appear as shown in the screenshot above, proceed as follows:

1. Select the menu option **Schema design | Configure view**.
2. In the **Schema display configuration** dialog box, click the **Predefined** button.
3. Click **OK** to confirm.
4. In the same way, make the `creditCardInfo` element into a global complex type. This results in a type called `creditCardInfoType`.
5. Save the file.

4.3.3 Including Types

In this section, you will learn how the elements of an included schema are actually used in the target schema. To this aim, you have to open and edit the target schema, for example `dvd_order.xsd`, in XMLSpy.

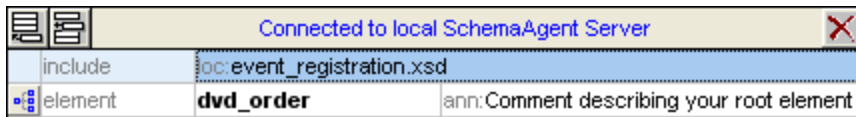

Notice that the schema contains an include statement, which was automatically added when you connected the two schemas in the [Include section](#) discussed previously. The global complex types that you have created in the [previous section](#) of the tutorial are now available in `dvd_order.xsd`.

To include `personInfoType` and `creditCardInfoType` in `dvd_order.xsd`:

1. [Open `dvd_order.xsd` in XMLSpy.](#)
2. In XMLSpy, click the **Display Diagram**  icon for the element `dvd_order` to display its content model.

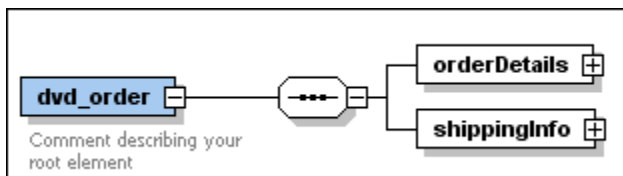

3. Right-click the sequence element and select **Add child | Element**.

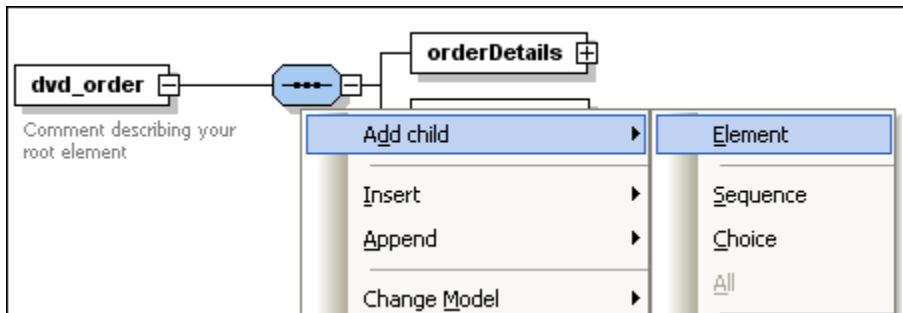

4. Enter "customerInfo" as the name for this element.
5. With this element still selected, in the Details entry helper, select `personInfoType` from the `type` drop-down list. Components that are part of a relation between the two schemas are in black, all others are in blue.

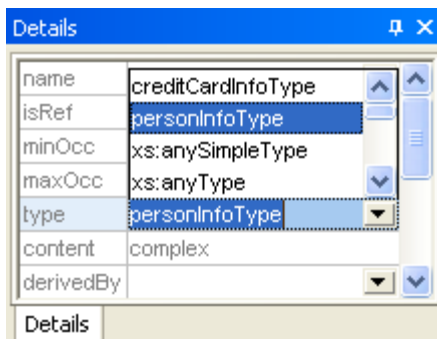

6. Right-click on the sequence element and select **Add child | Element**.
7. Enter "creditCardInfo" as the name for this element.
8. With this element still selected, in the Details entry helper, select `creditCardInfoType` from the `type` drop-down list.

9. Save the file.

You have now included two types from the schema `event_registration.xsd` in the schema `dvd_order.xsd`.

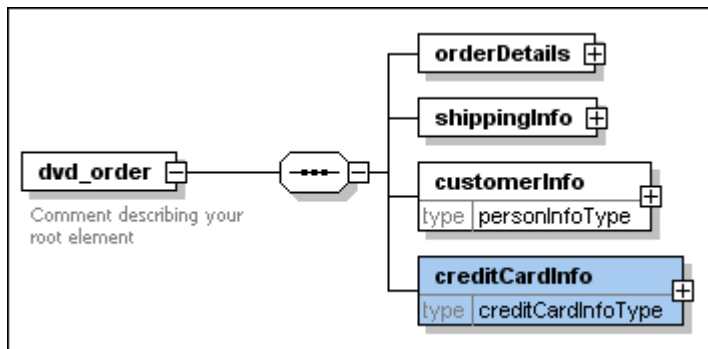

4.3.4 Redefining Types

In this section, you will learn how to redefine a type from one schema in another schema. You will also learn how to add a new element to a redefined type. This is also done in XMLSpy. For the purpose of this tutorial, we will use the schema `book_order.xsd` as an example.

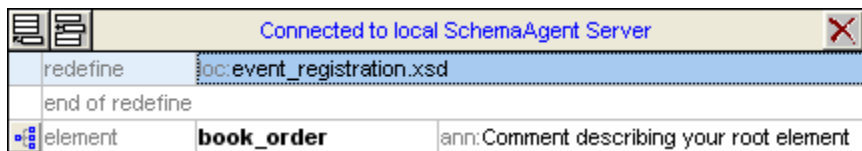

Notice that the schema contains a `redefine` statement, which was automatically added when you connected the two schemas in the [Redefine section](#) discussed previously.

To redefine the type `PersonInfoType`:

1. [Open `book_order.xsd` in XMLSpy.](#)
2. Select the line that says "end of redefine" and click the **Insert**  icon.
3. Select **ComplexType** from the menu that pops up and enter "personInfoType" as the name for this type.

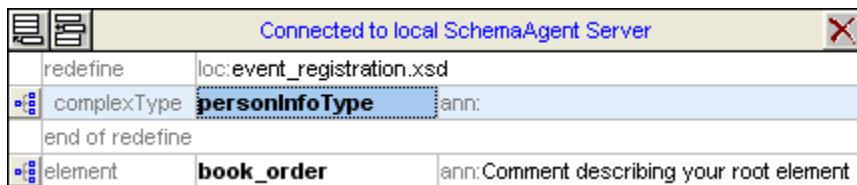

4. Click the **Display Diagram**  icon for `personInfoType`. The content model of `personInfoType`, as defined in `event_registration.xsd`, appears.

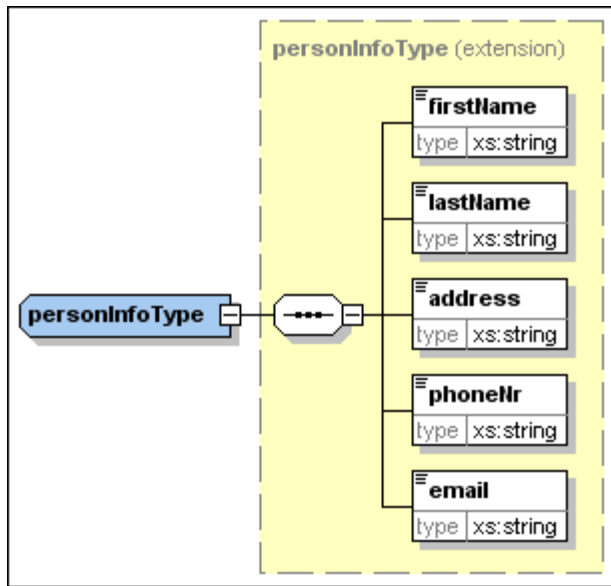

- Right-click the `personInfoType` complexType, and select **Add child | Sequence** from the context menu.

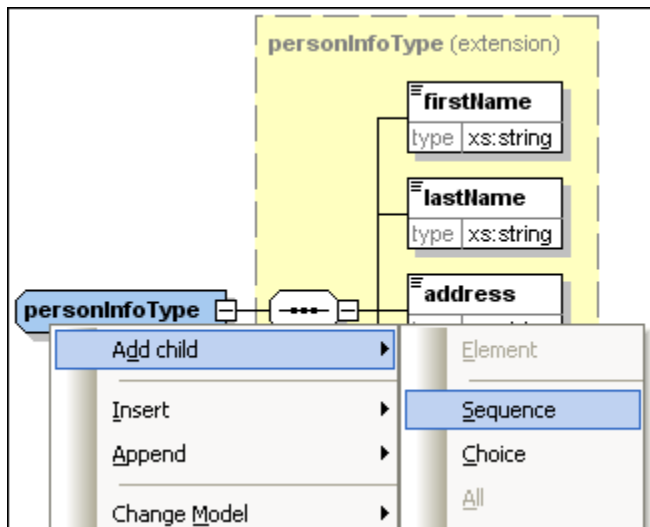

- Right-click the new sequence icon and select **Add Child | Element** from the context menu.

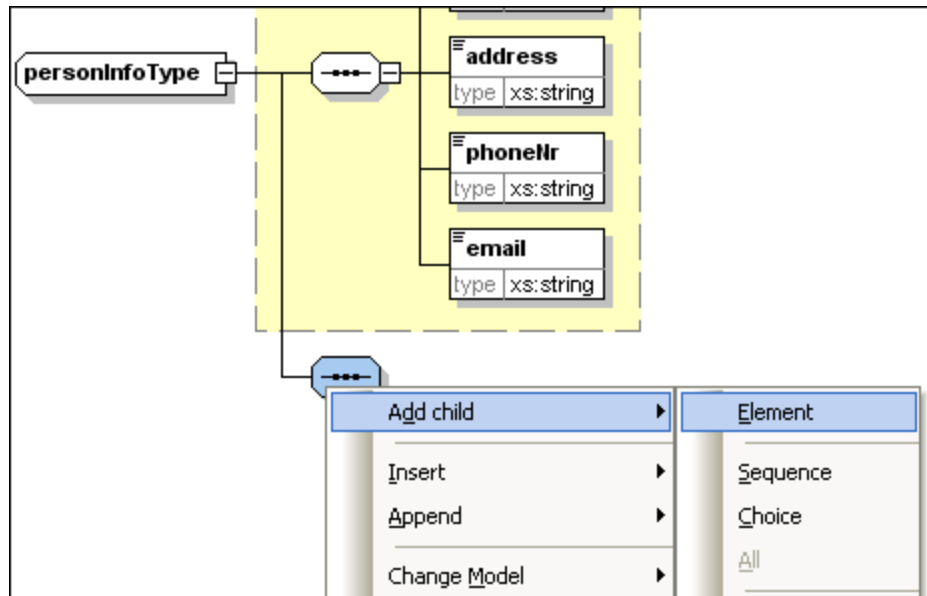

7. Enter "customerNumber" as the name for this element.
8. In the Details entry helper, select `xs:string` from the `type` drop-down list.

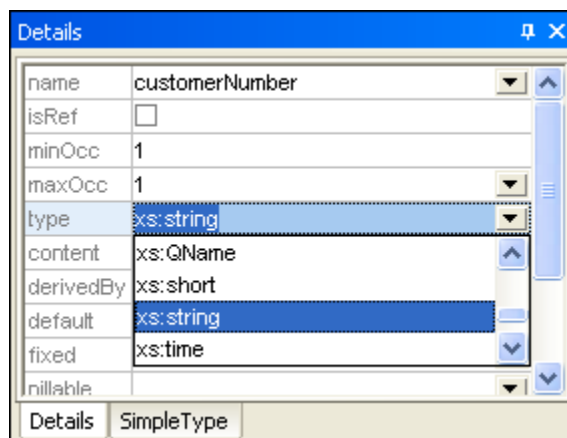

9. Save the file.
You have now redefined `personInfoType` to be used as a type in the XML schema `book_order.xsd`.

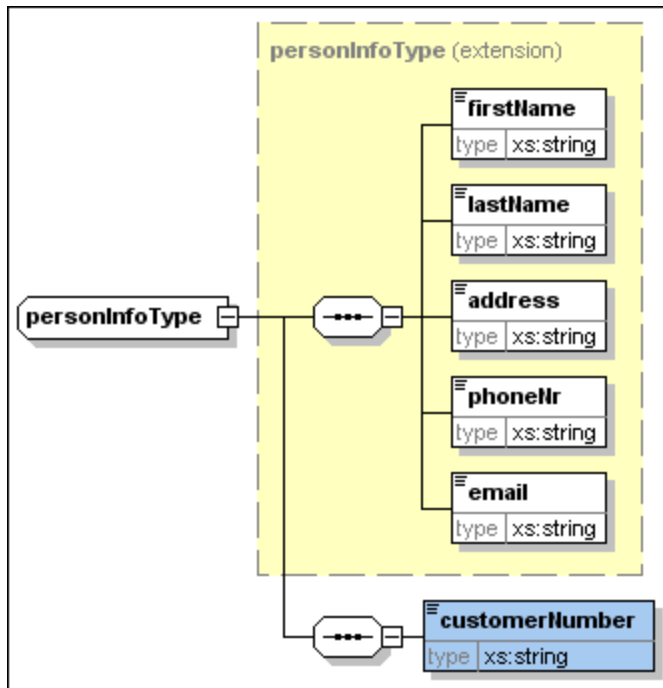

4.3.5 Using Redefined Types

In the [previous section](#), you redefined schema `event_registration.xsd` in schema `book_order.xsd` by adding a customer number to the complex type `personInfoType`. In this section, you will learn how to use this redefined complex type in schema `book_order.xsd`.

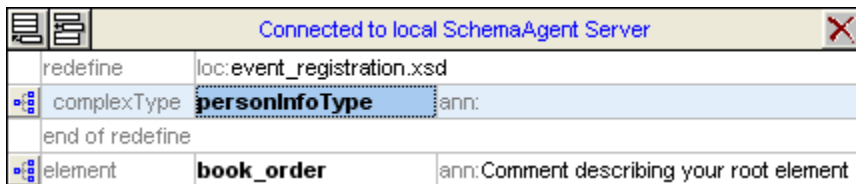

To use a redefined type in the target schema:

1. In the schema overview for `book_order.xsd`, click the **Display Diagram** icon of the root element `book_order`.

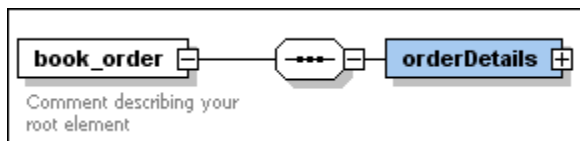

2. Right-click the sequence element and select **Add child | Element** from the context menu.

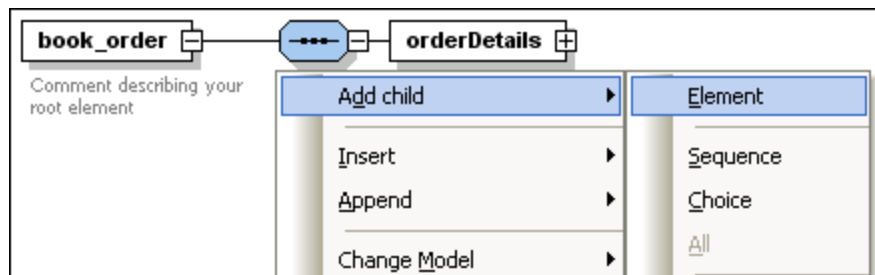

3. Enter "customerInfo" as the name for this element.
4. With this element still selected, in the Details entry helper, select `personInfoType` from the `type` drop-down list. Components from both schemas are in black, all others are in blue.

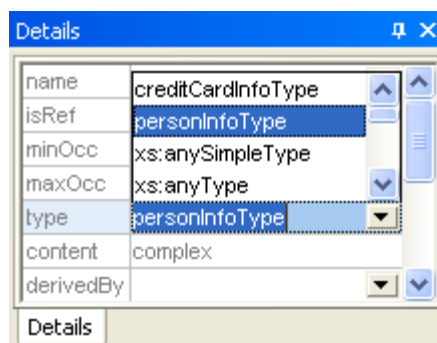

The redefined type is now being used as the type of an element in `book_order.xsd`.

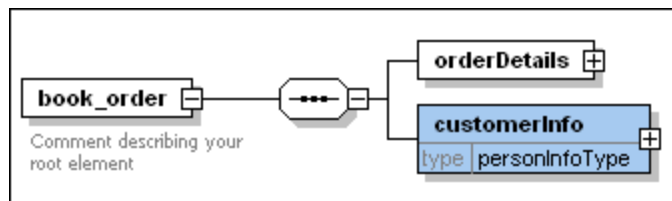

Using types without redefinition

Within a redefine relationship, you can also use types from the source schema without redefining them in the target schema.

To use a type in the target schema as is:

1. In the display diagram for the element `book_order`, right-click on the sequence element and select **Add child | Element** from the context menu.
2. Enter "creditCardInfo" as the name for this element.
3. With this element still selected, in the Details entry helper, select `creditCardInfoType` from the `type` drop-down list.
4. Save the file.

The type `creditCardInfoType` is now being used as the type of an element in `book_order.xsd`.

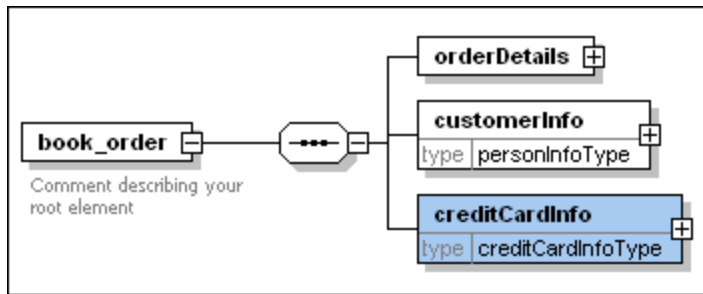

4.3.6 Importing Types

In our tutorial example, the schema `book_store.xsd` has a different namespace from the schema `library.xsd`. Therefore, to use elements from `book_store.xsd` in `library.xsd`, these elements must be imported. In this section, you will learn how to import a type that stores information about books from `book_store.xsd` to `library.xsd`.

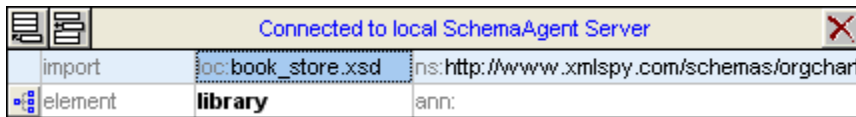

Notice that the schema contains an import statement, which was automatically added when you connected the two schemas in the [Import section](#) discussed previously. Also note that the namespace is specified in the `ns` field of the import statement. In this section, you will use a type from the imported schema in the importing schema.

To make the component book into a global complex type:

1. [Open the book_store.xsd schema in XMLSpy.](#)
2. In XMLSpy, click the **Display Diagram** icon for the element `book_store` to display its content model.
3. Click the "+" icon to expand the `bookInfo` element.

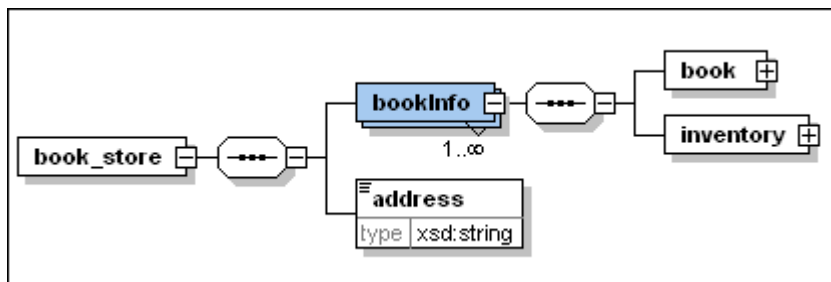

4. Right-click the `book` element and select **Make Global | Complex type** from the context menu.
5. Save the file.

To import bookType to library.xsd:

1. [Open the library.xsd schema in XMLSpy.](#)
2. In XMLSpy, click the **Display Diagram** icon for the element `library` to show its content model.

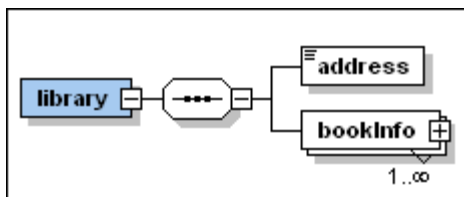

3. Click the "+" icon to expand the bookInfo element.

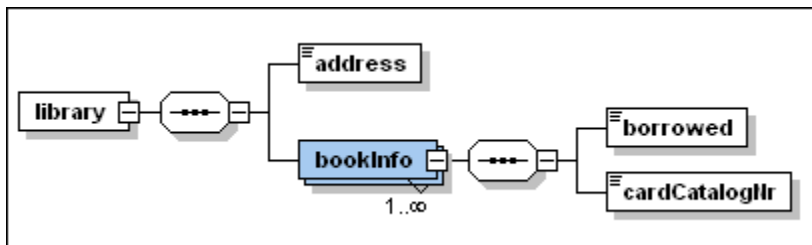

4. Right-click the sequence icon after the `bookInfo` element and select **Add child | Element** from the context menu.
5. Enter "bookDetails" as the name for the element.
6. With this element still selected, in the Details entry helper, select `ns2:bookType` from the `type` drop-down list. Components from both schemas are in black, all others are in blue.

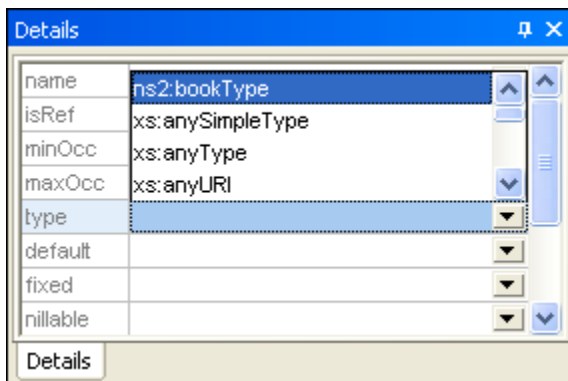

7. Save and close all files that are currently open in XMLSpy.
 You have now imported a type from the schema `book_store.xsd` to the schema `library.xsd`.

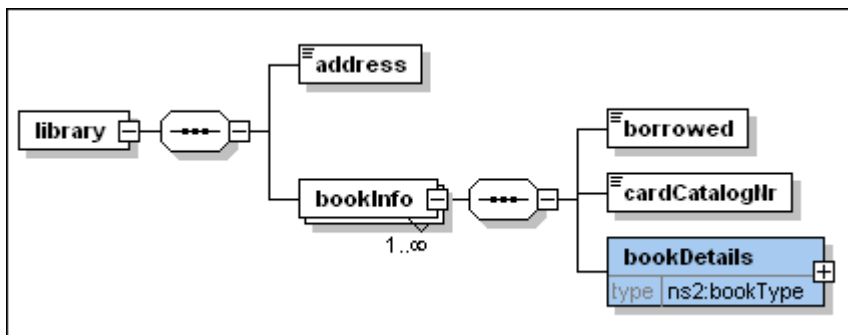

4.3.7 Including Types Using Only XMLSpy

In this section you will use only XMLSpy as a client [connected to the SchemaAgent LocalServer](#) to create an include relationship between the following schemas provided in the include2 sub-folder of the SchemaAgentExamples\Tutorial folder:

- **company1.xsd**: This schema is structured to contain information about a company and its employees.
- **company2.xsd**: This schema is structured to contain information about the products of a company.

In the course of this example, you will include the address and employee components from `company1.xsd` in `company2.xsd`.

To make the components to be included into global complex types:

1. [Open the company1.xsd schema in XMLSpy.](#)
2. Make sure that you are [connected](#) to the SchemaAgent LocalServer.
3. In XMLSpy, click the **Display Diagram**  icon for the root element `company1` to display its content model.

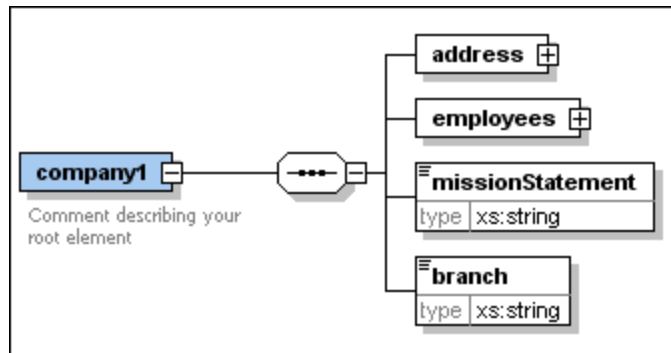

4. Right-click the `address` element and select **Make Global | Complex type** from the context menu. A new global complex type called `addressType` is created.
5. Click the "+" icon to expand the `employees` element.

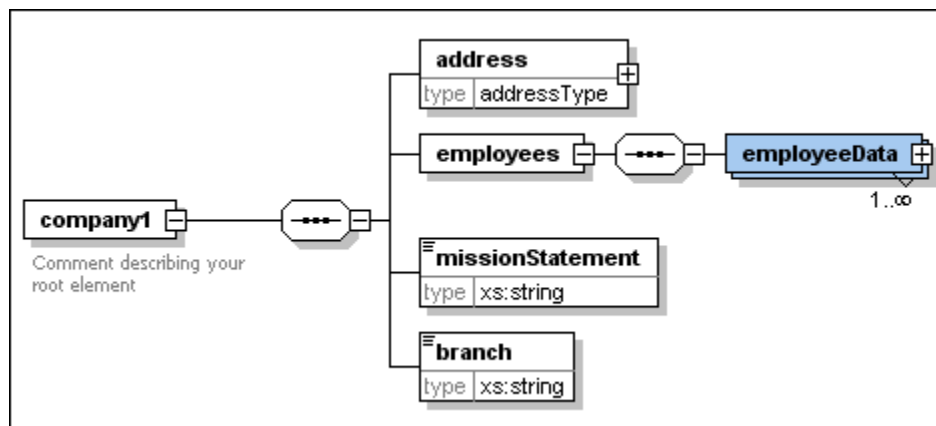

6. In the same way, make the `employeeData` element into a global complex type. This results in a type called `employeeDataType`.
7. Save the file.

To include global complex types in schemas using XMLSpy:

1. Open the target schema, `company2.xsd` in this example, in XMLSpy.
2. Make sure that you are [connected](#) to the SchemaAgent LocalServer.
3. In XMLSpy, click the **Display Diagram**  icon for the root element `company2` to display its content model.

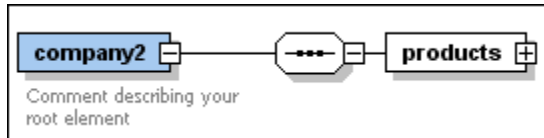

4. Right-click the sequence element and select **Add child | Element** from the context menu.
5. Enter "companyAddress" as the name for this element.
6. With this element still selected, in the Details entry helper, select `addressType` from the `type` drop-down list. The word "addressType" is in blue because there is no include, import or redefine relationship between the schemas.

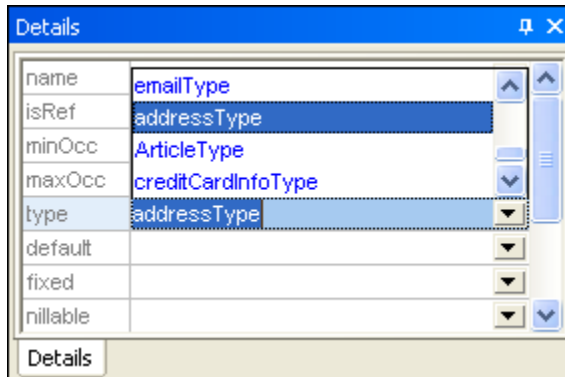

7. A dialog box opens where you can select which type of relationship you want to have between the two schemas.

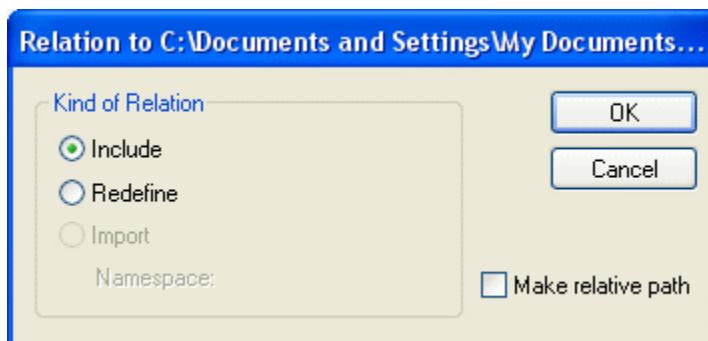

8. Select `Include` and confirm with **OK**. This inserts an include statement into the `company2.xsd` schema.
9. Repeat steps 3 to 5 to create a further element with the name "employee" and of type "employeeDataType". Notice that when in the Details entry helper you select `employeeDataType` from the `type` drop-down list, it is in black, because there is now an include relationship between the schemas.

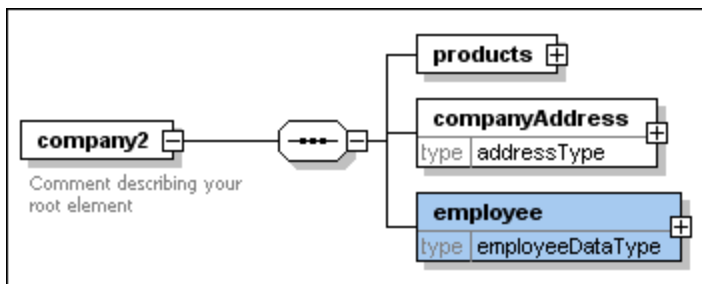

10. Save the file.

You have now included two types from the schema `company1.xsd` in the schema `company2.xsd`.

To view the include statement that has been inserted:

- Click the **Display All Globals**  icon.



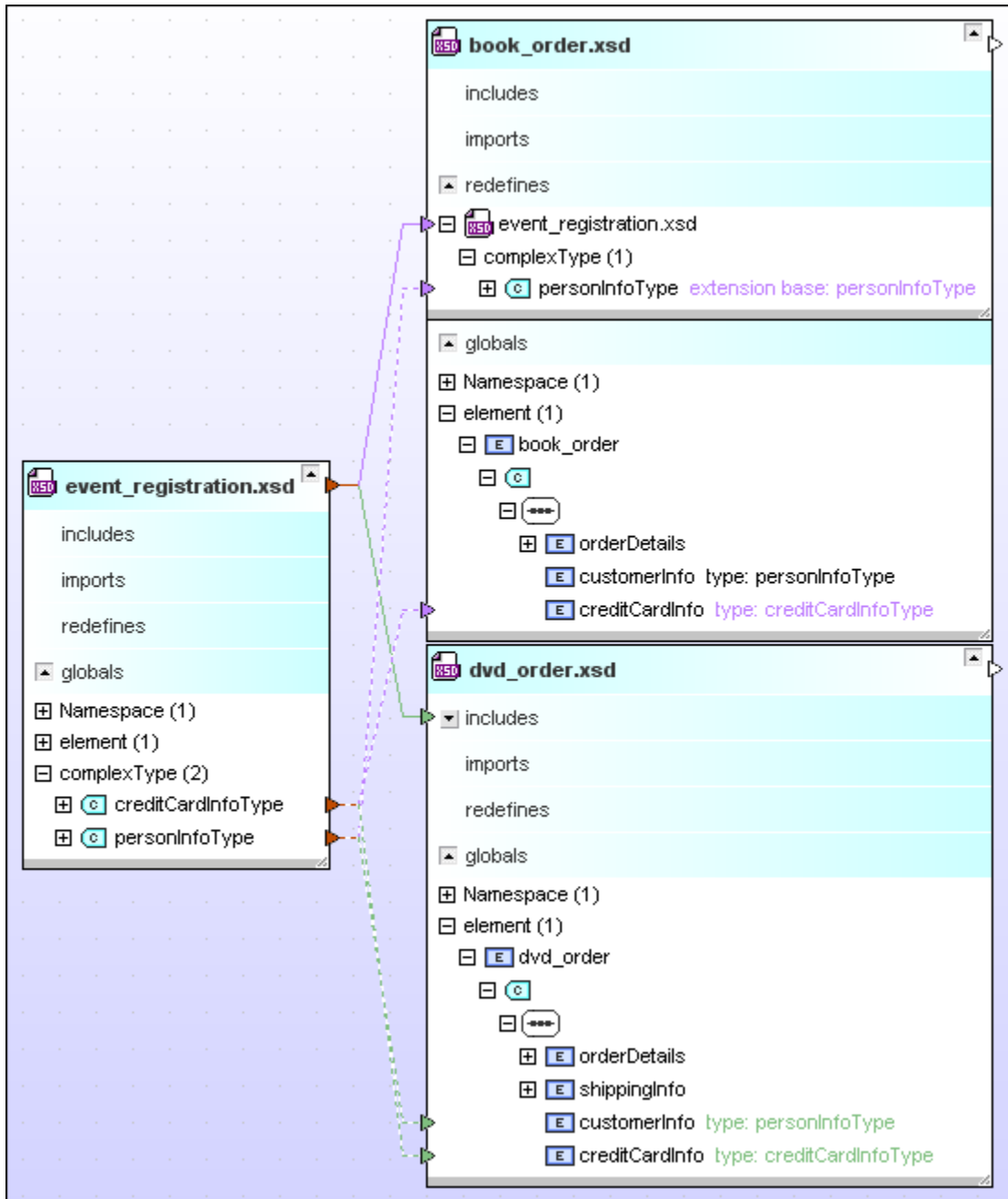

4.4 Viewing the Updated Relationships

In this section, you will use SchemaAgent Client to view the include and redefine relationships that you created between schemas in the course of this tutorial.



To view the updated relationships:

1. In SchemaAgent Client, make the Design tab active that contains the files event_registration.xsd, dvd_order.xsd, and book_order.xsd.
2. Click the expand  icon in each of the file boxes to expand it.
3. Click the "globals" expand  icon in each of the file boxes.

4. In `event_registration.xsd`, expand "complexType".
5. In `dvd_order.xsd`, click "element" and continue to expand its sub-elements until you see "customerInfo" and "creditCardInfo".
6. In `book_order.xsd`, expand "redefines" and continue to expand its sub-elements until you see "personInfoType".

Now you can see exactly what elements were included or redefined in other schemas.

4.5 Viewing MapForce Design (MFD) Files



In this section, you will learn how to use SchemaAgent Client to view the components of MapForce Design (MFD) files. Drag the MFD files from the Explorer and drop them onto a Design window. Using the options in the context menu, you can also insert all (directly) referenced or linked files into the design.

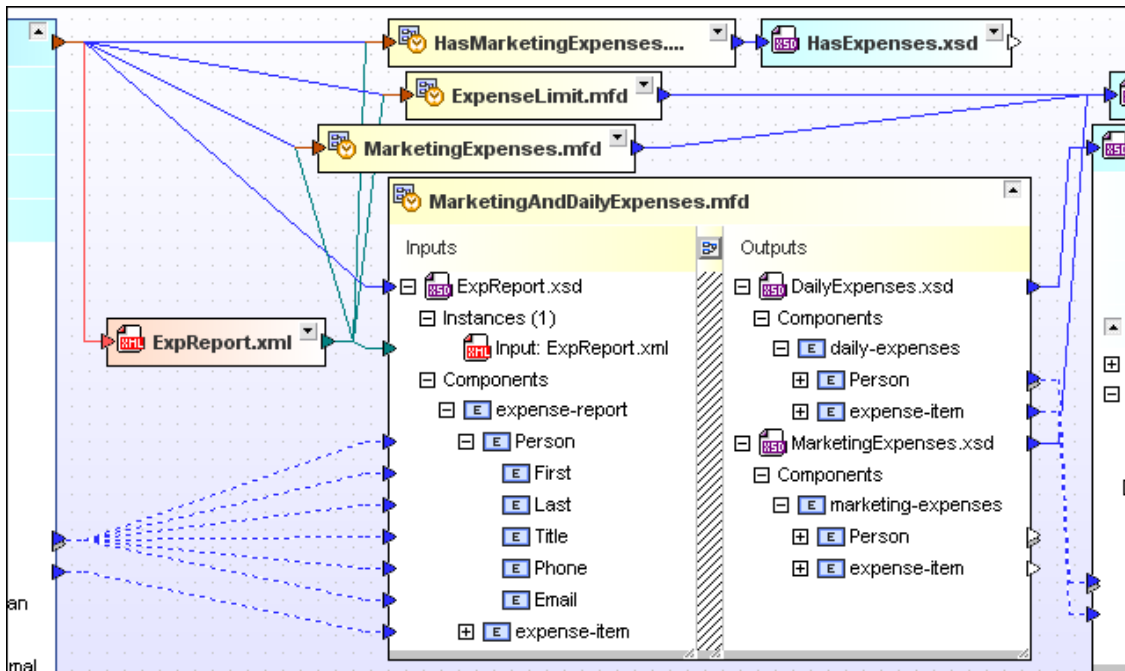

Expand the MFD file boxes and the individual sections within them to see the details of the IIR relations between the MFD files, XML schemas, and XML instances. Use the context menu to expand or collapse children and to adapt the size of the file box to view all expanded details.



To view MapForce design (MFD) files in SchemaAgent:

1. In SchemaAgent Client, select the menu option **File | New**, or click the **New**  icon in the Standard toolbar, or press **Ctrl+N** to open a new Design window.
2. In the Explorer window, select `ExpenseLimit.mfd`, `HasMarketingExpenses.mfd`, `MarketingAndDailyExpenses.mfd`, and `MarketingExpenses.mfd` from the `MapForce` folder and drag them into the Design window.
3. Right-click the files and select **Insert | All directly referenced | Files** from the context menu.
The related XML schemas and their relationships appear in the Design window.
4. Click the expand  icon to expand the file box of each of the MFD files.

Now you can see the MapForce Design files and their related XML schemas.

5. Click the expand button in front of an XML schema to view its XML instances and components. To expand all children of an item, right-click that item and select **Expand all children** from the context menu.
6. To resize the file box and view all expanded items, right-click anywhere into the white area of the file box and select **Size to fit** from the context menu.
7. Optionally, position the cursor over the title bar of a MapForce file box to get a Quickinfo bubble that displays information about that file.

Chapter 5

SchemaAgent Server

5 SchemaAgent Server

SchemaAgent Server reads information about the supported files in a folder you identify (and optionally in that folder's sub/folders)—the search path. SchemaAgent Server determines the relationships between, and creates an internal map of these files and their components. You can define multiple search paths.

You can administer the relationships between one or more files in the defined search paths from within the SchemaAgent Client GUI. The relationships between files can be modified using SchemaAgent clients, and the modified relationships are propagated through the affected file via SchemaAgent Server. Information about the files in the search path(s) and the relationships between these files is then served to SchemaAgent clients that connect to SchemaAgent Server.

SchemaAgent Server processes client requests to create, update, or delete schema IIRs (Includes, Imports, and Redefines) and references between schemas and supported files, and manages the communication between SchemaAgent Server and its clients. IIR (Include, Import, and Redefine) relationships between files can be modified and files can be deleted in SchemaAgent clients. These modifications and deletions are implemented in the actual files via SchemaAgent Server. SchemaAgent Server processes client requests to create, update, or delete schema IIRs (Includes, Imports, and Redefines) and to manipulate files, and it manages the communication between SchemaAgent Server and its clients.

SchemaAgent clients use the internal map that is created in SchemaAgent Server. This map is created or updated when: (i) a new search path is created, or (ii) an existing search path is modified within SchemaAgent Server; or (iii) SchemaAgent Server is started with search paths already defined. If the contents of a folder are physically modified (for example, if a file is physically deleted from the repository—and not from within a SchemaAgent client) after SchemaAgent Server has been started, then SchemaAgent Server's internal schema map is **not** automatically updated, and SchemaAgent clients will continue to use the original map.

Please note: SchemaAgent Server and its clients transfer data using UDP and TCP over **port 2799**.

5.1 Installing SchemaAgent Server

The SchemaAgent Server installation package can be downloaded free of charge from the [SchemaAgent download page](#).

During the installation process of SchemaAgent Server, you are presented with a dialog box, where you can choose from among several options how you want to install and start your SchemaAgent server application: You can install and start SchemaAgent Server as a [standalone server](#), or install it as a [service](#) or an [interactive service](#). These options determine the level of user interactivity required to start SchemaAgent Server on your computer. Optionally, you can also choose to start the SchemaAgent Service immediately after installation.

Changing SchemaAgent Server's installation method using the Command Line

If you want to change SchemaAgent Server's installation method after you have installed the program, you can do so by calling SchemaAgentServer.exe using the command line. Otherwise you would have to uninstall SchemaAgent Server and reinstall it choosing a different installation method.

The commands listed below are available when calling SchemaAgentServer.exe from the command line. The EXE always returns a return code when run in command-line mode. If an error is encountered using the install and remove parameters, then the returned error code is identical to the code supplied by the operating system.

No command line parameters	Start as GUI application.
<code>/install</code> or <code>-install</code>	Install as a (non-interactive) service (creates an entry in the SCM Database*).
<code>/install:interactive</code> or <code>-install:interactive</code>	Install as an interactive service (creates an entry in the SCM Database*).
<code>/remove</code> or <code>-remove</code>	Uninstalls the service (deletes entry from the SCM-Database*).
<code>/quiet</code> or <code>-quiet</code>	Suppresses message boxes that appear when an error occurs using the Install or Remove commands.

* The Service Control Manager (SCM) maintains a database of installed services and driver services, and provides a unified and secure means of controlling them. The database includes information on how each service or driver service should be started. It also enables system administrators to customize security requirements for each service and thereby control access to the service. (Source: MSDN Library)

To install SchemaAgent Server:

1. Double-click the SchemaAgent Server installer file.
2. Follow the on-screen instructions.
During the installation process, you will be given a choice of whether you wish to install SchemaAgent Server as a [standalone server](#), an [interactive service](#), or a [\(non-interactive\) service](#).

To change the installation method:

1. To exit a running SchemaAgent Server server, do one of the following:
 - Right-click the **Altova SchemaAgent Server**  application icon in the system tray and select **Shutdown** from the context menu.

- Click **Start | Control Panel**, double-click **Administrative Tools** and **Services**, right-click the **SchemaAgent Server Service** and choose **Stop** from the context menu.
2. Click **Start | All Programs | Accessories | Command Prompt** to open a command line window.
 3. In the **Command Prompt** window, change to the installation folder of SchemaAgent Server (C:\Program Files\Altova\SchemaAgentServer2012 by default).
 4. If applicable, enter `SchemaAgentServer.exe /remove` to uninstall an existing SchemaAgent Server service, and press the **Enter** key.
 5. Enter `SchemaAgentServer.exe /install` to install SchemaAgent Server as a service and add `:interactive` (without blank before the colon) to install it as an interactive service. To start SchemaAgent Server as a stand-alone installation, enter just `SchemaAgentServer.exe`.
 6. Press **Enter** to start the installation and close the **Command Prompt** window.
 7. If required, click **Start | Control Panel**, double-click **Administrative Tools** and **Services**, right-click the **SchemaAgent Server Service** and choose **Start** from the context menu to start the service.

5.1.1 Standalone Server

When installed as a standalone server, SchemaAgent Server can be started from the **Start | All Programs** menu or from a desktop icon. The application opens in a GUI, and, when started, an application icon  appears in the system tray. SchemaAgent Server can be configured (that is, have [search paths defined](#) for it) directly in the GUI. This installation is well suited for installation on a local machine.

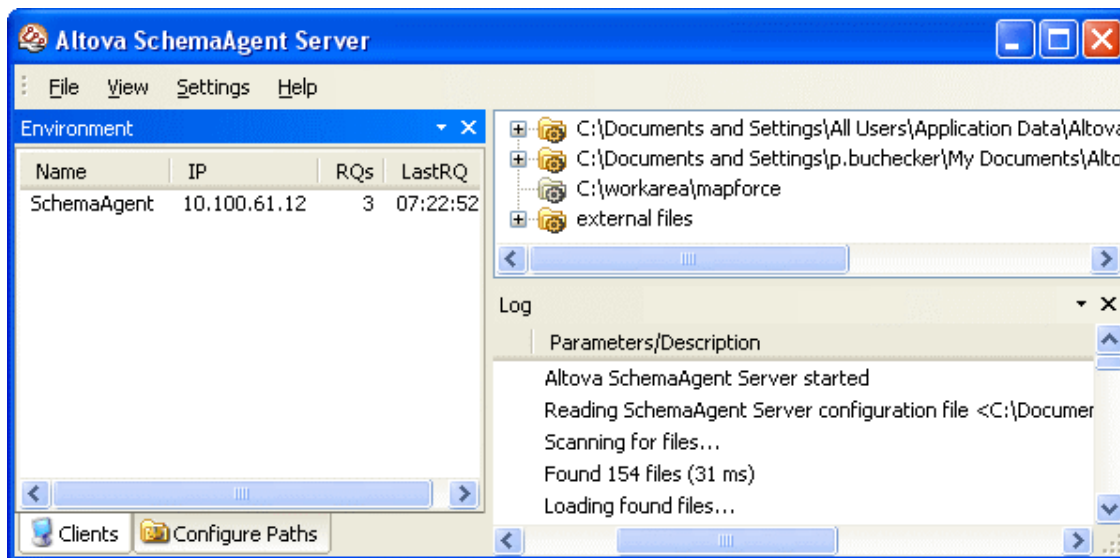

To install SchemaAgent Server as a standalone server:

1. Double-click the SchemaAgent Server installer file.
2. When prompted, choose `Install` and `Start SchemaAgent Server as Standalone Server`.
3. Click **Next** and follow the on-screen instructions.

5.1.2 Interactive Service

Installing SchemaAgent Server as an interactive service causes SchemaAgent Server to be started automatically on every system start. The SchemaAgent Server application icon is available in the system tray, and the application can be started and stopped using the system tray icon. SchemaAgent Server can also be started and stopped using operating system tools (in Windows XP, **Administrative Tools | Services**).

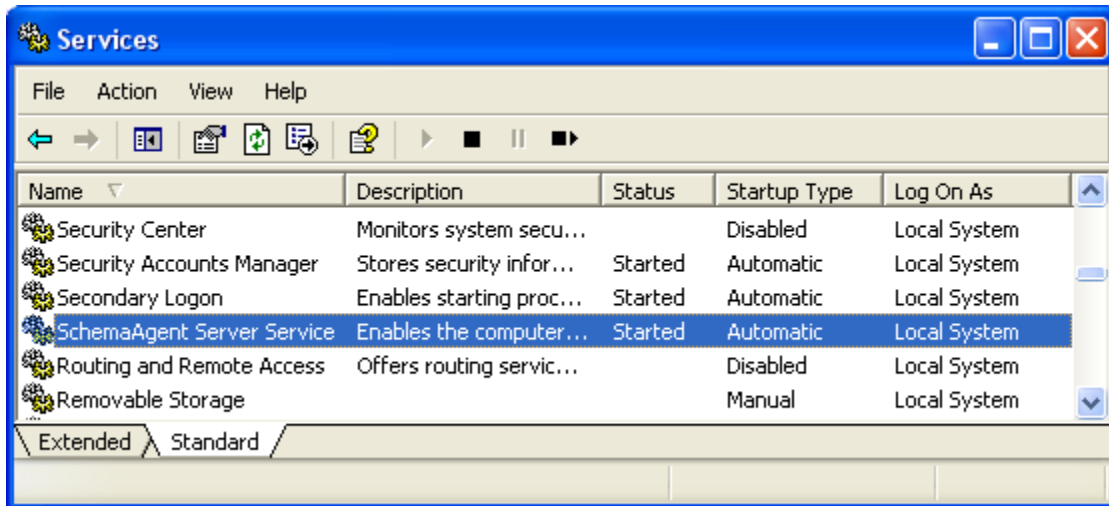

Installing SchemaAgent Server as an interactive service saves you the task of starting and stopping the service manually. Clicking the application icon in the system tray enables you to [show/hide the GUI](#), [change the configuration](#) settings, and [shutdown](#) SchemaAgent Server. This type of installation is best if SchemaAgent Server is to act as a network server for multiple clients.

To install SchemaAgent Server as an interactive service:

1. Double-click the SchemaAgent Server installer file.
2. When prompted, choose `Install SchemaAgent Server as an Interactive Service`.
3. Click **Next** and follow the on-screen instructions.

5.1.3 Non-Interactive Service

Installing SchemaAgent Server as a non-interactive service completely hides it from users. The operating system starts SchemaAgent Server automatically on every system start. No system tray icon is available when SchemaAgent Server is installed as a (non-interactive) service.

Please note: In order to configure SchemaAgent Server (that is, define search paths), you must first install SchemaAgent Server as an [interactive service](#), configure it, and then run it as a non-interactive service.

To configure SchemaAgent Server and run it as a (non-interactive) service:

1. Install SchemaAgent Server as [interactive service](#).
2. Define the configuration settings in the GUI.
3. In your Windows desktop, click **Start** and choose **Control Panel**.
4. Click **Administrative Tools** and choose **Services**.

5. Right-click the SchemaAgent Service and choose **Properties** from the context menu or select the menu option **Action | Properties**.
6. In the **SchemaAgent Server Service Properties** dialog box, change to the **Log On** tab and deactivate the `Allow service to interact with desktop` check box.
7. Click **OK**.
8. Restart the SchemaAgent Service (menu option **Action | Restart**).
The **Altova SchemaAgent Server**  icon disappears from the system tray and interaction with the desktop is no longer possible.

To install SchemaAgent Server as a (non-interactive) service:

1. Double-click the SchemaAgent Server installer file.
2. When prompted, choose `Install SchemaAgent Server as a Service`.
3. Click **Next** and follow the on-screen instructions.

5.2 Starting SchemaAgent Server

If you have installed SchemaAgent Server as a [standalone server](#), you must start the server application before SchemaAgent Client can connect to it. A SchemaAgent Server application that has been installed as a service (be it [interactive](#) or [non-interactive](#)) is started automatically on system start.

Please note: Only one instance of SchemaAgent Server can be started at a time. If you try to start SchemaAgent Server when it is already running (indicated by the **Altova SchemaAgent Server**  icon in the system tray), an error message appears.

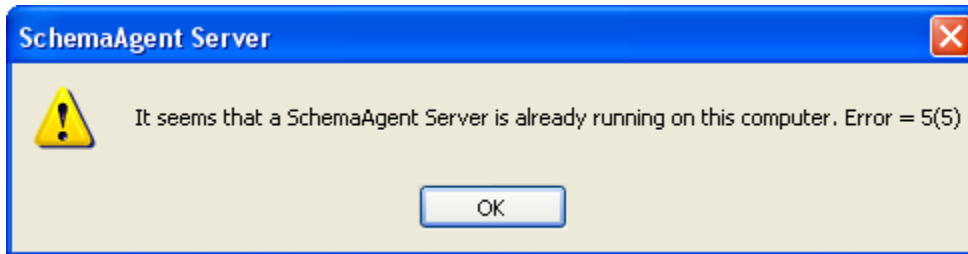

To start SchemaAgent Server:

- In the Windows **Start** menu, select **All Programs | Altova SchemaAgent Server 2012 | Altova SchemaAgent Server**.
The [SchemaAgent Server GUI](#) appears.

5.3 Hiding and Exiting SchemaAgent Server

After you have configured the [search paths](#) and the [file extensions](#) to search for in the path as desired, you can either decide to run SchemaAgent Server as a (non-interactive) service and thus make it completely unavailable to the users, or hide the application in the system tray.

Exiting SchemaAgent Server

Please note that if you exit SchemaAgent Server while clients are still connected, these clients will lose their connection to SchemaAgent Server and thus will not be able to process commands that depend on a connection to SchemaAgent Server (e.g., commands such as creating or modifying an IIR relationship in a SchemaAgent design). Therefore, a prompt appears in this case, displaying the number of currently connected clients and asking whether shutdown should be continued.

To hide SchemaAgent Server in the system tray:

- Right-click the **Altova SchemaAgent Server**  application icon in the system tray and activate **Hide** in the context menu.

To show SchemaAgent Server when hidden in the system tray:

Do one of the following:

- Right-click the **Altova SchemaAgent Server**  application icon in the system tray and deactivate **Hide** in the context menu.
- Double-click the application icon in the system tray.

To exit SchemaAgent Server:

Do one of the following:

- In the SchemaAgent Server GUI, select the menu option **File | Shutdown**.
- Right-click the **Altova SchemaAgent Server**  application icon in the system tray and select **Shutdown** from the context menu.

5.4 The SchemaAgent Server User Interface

The graphical user interface (GUI) is available if you have installed SchemaAgent Server as a [standalone server](#) or as an [interactive service](#). If you have installed and started SchemaAgent Server as a [non-interactive service](#), no GUI will be available. The graphical interface is organized into three broad parts:

- The [Environment window](#) provides you with information about search paths and files available herein.
- The **Main window** (located in the upper right part of the application) shows the content of the folders defined in the search paths.
- The [Log window](#) shows client requests, server responses, and other server-related data.

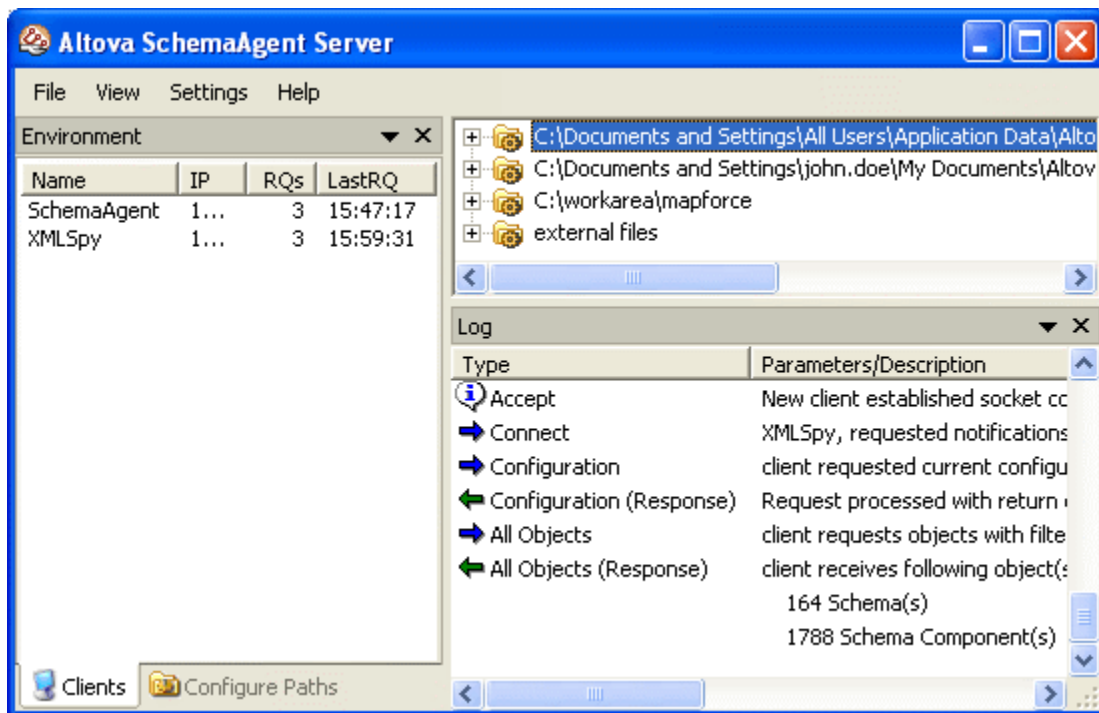

5.4.1 Environment Window

The **Clients** tab displays details about the clients that are currently connected to SchemaAgent Server. Connections to SchemaAgent Server are initiated by a request from the client, and must be made from the client.

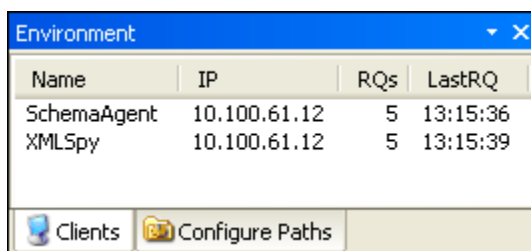

The above screenshot shows that two clients, SchemaAgent Client and XMLSpy, are currently connected to SchemaAgent Server. The IP addresses of the connected clients are also listed. The number of requests made by a client is shown in the RQs column, and the time of the last

request made by each client is shown in the LastRQ column.

The **Configure Paths** tab displays the search paths as well as the file extensions of the files the paths are searched for. Please see chapter [Configuring Search Paths](#) for details on how to configure the search paths in SchemaAgent.

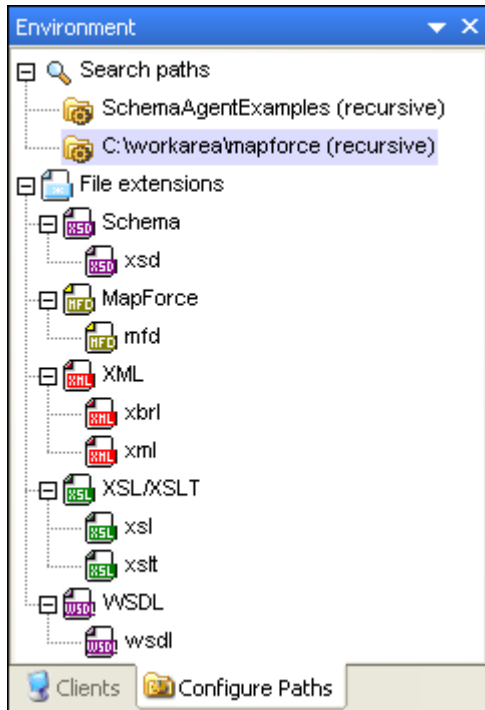

To view connections to SchemaAgent Server:

- In the Environment window, click the **Clients** tab.

To configure the search paths in SchemaAgent Server:

- See the following chapters in the SchemaAgent documentation for details:
 - [Adding or Editing Search Paths](#)
 - [Configuring File Extensions](#)
 - [Reloading or Resetting Search Paths](#)

5.4.2 Log Window

The Log window shows client requests, server responses, and other server-related data. This data is presented as a description, together with the time of execution (in the case of actions) or the time of data transfer (in the case of notifications). When the information involves a client, the client is listed together with its IP address.

Type	Parameters/Description	Source/Target	IP	Time
➔ Relation Change	client requests relation change	SchemaAgent	10.100.61.12	15:26:58
	Redefine - ipo2.xsd in address2.xsd			15:26:58
	Schema C:\Program Files\Altova\Schem...			15:26:58
	Schema C:\Program Files\Altova\Schem...			15:26:58
← Relation Change (Response)	Request processed with return code 0	SchemaAgent	10.100.61.12	15:26:58
➔ Single Object	client requests objects with filter 0 and ...	SchemaAgent	10.100.61.12	15:26:58
← Single Object (Response)	client receives following objects: 1 R...	SchemaAgent	10.100.61.12	15:26:58
ⓘ Disconnect	Client closed the socket	SchemaAgent	10.100.61.12	15:28:49
	Last client disconnected			15:28:49
ⓘ Accept	New client established socket connection		10.100.61.12	15:29:18
➔ Connect	XMLSpy, requested notifications 0xFFFF...	XMLSpy	10.100.61.12	15:29:18
➔ Configuration	client requested current configuration	XMLSpy	10.100.61.12	15:29:18
← Configuration (Response)	Request processed with return code 0	XMLSpy	10.100.61.12	15:29:18
➔ All Objects	client requests objects with filter 4 and ...	XMLSpy	10.100.61.12	15:29:18
← All Objects (Response)	client receives following objects:	XMLSpy	10.100.61.12	15:29:55
	0 Config Paths			15:29:55
	0 Directories			15:29:55
	458 Schemas			15:29:55
	0 MapForce Mappings			15:29:55
	7643 Schema Components			15:29:55
	0 Relations			15:29:55
	0 Schema Component Relations			15:29:55

The following symbols are used in the Log window:

- ➔ Requests from the client (blue, right-pointing arrow)
- ← Responses from the server (green, left-pointing arrow)
- ⓘ Information regarding connection or disconnection of a client

The source client (of requests) and target client (for responses) are indicated in the Source/Target column. The Parameters/Description column shows the kind of action, while the Time column gives the time of the action.

Each time a search path is modified in SchemaAgent Server (for example, if the **Recursive** option is disabled for a search path), the modified file structure is sent by SchemaAgent Server to all connected clients.

If a folder that is in a search path has its structure modified outside SchemaAgent Server (for example, if a subfolder is deleted from the repository), then this information is not updated in SchemaAgent Server until search paths are reloaded.

The Failed to read <file type> file message appears when a file includes or imports other files which cannot be found at the location specified.

5.5 Configuring the SchemaAgent Server GUI

SchemaAgent Server's graphical user interface allows you to configure the appearance and the logging options of the application.

Changing the display of the windows

The Environment and Log windows can be closed by either clicking the **Close** button at the top-right of the respective pane or by right-clicking into the Log window or the Clients tab of the Environment window, respectively, and deactivating the desired window in the context menu that pops up.

Double-clicking the title bar of the Environment and Log windows enables you to dock or undock these two windows in the application window. When you drag the title bar of a window, you can position that window freely anywhere in your workspace. When dragging a window, blue placement arrows appear in the SchemaAgent Server application window. Dragging the window over one of these placement arrows docks the window at the location indicated by that placement arrow. The four outer placement arrows dock the window along each of the four edges, respectively. The four inner placement arrows dock the window relative to the panes located along the edges.

Setting the logging options

You can choose whether you like to have SchemaAgent Server's actions online in the Log window or to write them to a log file. The logging options can be configured in the **SchemaAgent Server Logging Options** dialog box (see *screenshot*).

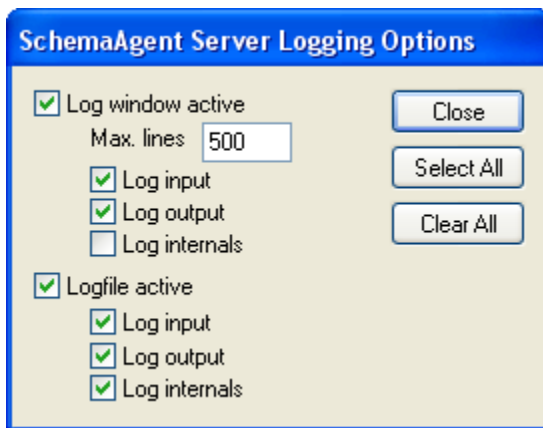

Selecting the `Log window active` check box causes SchemaAgent Server actions to be displayed in the Log window. Selecting the `Logfile active` check box causes SchemaAgent Server actions to be written to a log file. The log file is a Comma Separated Values (CSV) file named `SchemaAgentServerLog.csv` and is created in the same folder as SchemaAgent Server each time you start a SchemaAgent Server session, provided that the `Logfile active` check box is activated.

- The `Log input` option enables/disables the display of incoming requests.
- The `Log output` option enables/disables the display of outgoing responses.
- The `Log internals` option enables/disables the display of internal SchemaAgent Server information.

To switch individual windows in SchemaAgent Server on or off:

1. Do one of the following:
 - Select the menu option **View | Toolbars**.
 - Right-click anywhere in the Log window or the Clients tab of the Environment window.
2. Activate or deactivate the window you want to display or hide, respectively.
Display of the pane is toggled on or off.

To configure the logging options:

1. Select the menu option **Settings | Logging Options**.
The **Logging Options** dialog box opens.
2. To activate the log window:
 1. Activate the `Log window active` check box.
 2. Specify the number of lines to be displayed in the Log window.
 3. Activate the respective check boxes to log input, output, or internals in the Log window.
3. To activate the log file:
 1. Activate the `Logfile active` check box.
 2. Activate the respective check boxes to log input, output, or internals in the log file.
4. Optionally, click **Select All** or **Clear All** to select, or clear, respectively, all check boxes.
5. Click **Close**.

5.6 User Reference

The **User Reference** section contains a complete description of all SchemaAgent Server menu commands. We've tried to make this user manual as comprehensive as possible. If, however, you have questions which are not covered in the User Reference or other parts of this documentation, please look up the FAQs and Discussion Forums on the [Altova website](#). If you are still not able to have your problem satisfactorily addressed, please do not hesitate to contact us through the [Support Center](#) on the Altova website.

5.6.1 File Menu

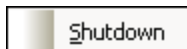

The **File | Shutdown** command [exits](#) SchemaAgent Server. Please note that all connections to clients will be lost.

5.6.2 View Menu

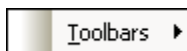

The **View | Toolbars** command opens a sub-menu, where you can toggle the display of the Environment and Log windows on and off.

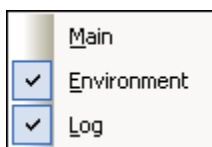

Deselect the respective menu option to hide the corresponding window.

5.6.3 Settings Menu

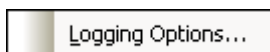

The **Settings | Logging Options...** command opens the **SchemaAgent Server Logging Options** dialog box which enables you to [configure the logging options](#) of SchemaAgent Server.

5.6.4 Help Menu

The **Help** menu contains commands required to get help or more information on SchemaAgent, as well as links to information and support pages on our web server.

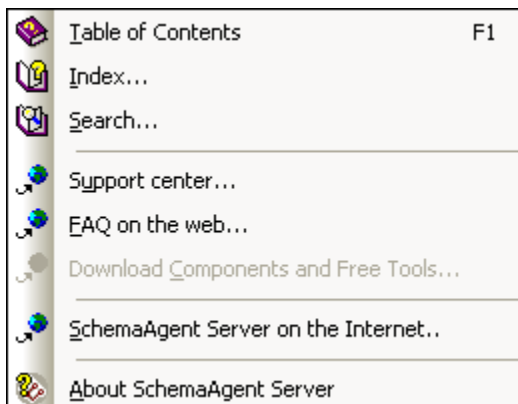

Table of Contents



F1

The **Table of Contents** command displays a **hierarchical representation** of all chapters and topics contained in the online help system. Use this command to jump to the table of contents directly from within SchemaAgent.

Once the help window is open, use the three tabs to navigate between the table of contents, [index](#), and [search](#) panes. The Favorites tab lets you bookmark certain pages within the help system.

Index...



The **Index...** command accesses the **keyword index** of the Online Help. You can also use the Index tab in the left pane of the online help system.

The index lists all relevant keywords and lets you navigate to a topic by double-clicking the respective keyword. If more than one topic matches the selected keyword, you are presented a list of available topics to choose from.

Search...



The **Search** command performs a **full-text search** on the entire online help system.

1. Enter your search term in the query field and press Enter.
The online help system displays a list of available topics that contain the search term you've entered.
2. Double-click on any item in the list to display the corresponding topic.

Support Center...

If you have any questions regarding our product, please feel free to use this command to send a query to the Altova Support Center at any time. This is the place where you'll find links to the FAQ, support form, and e-mail addresses for contacting our support staff directly.

FAQ on the Web...

To help you in getting the best support possible, we are providing a list of Frequently Asked Questions (FAQ) on the Internet, that is constantly updated as our support staff encounters new issues that are raised by our customers.

Please make sure to check the FAQ before contacting our technical support team. This will allow you to get help more quickly.

We regret that we are not able to offer technical support by phone at this time, but our support staff will typically answer your e-mail requests within one business day.

If you would like to make a feature suggestion for a future version of SchemaAgent Server or if you wish to send us any other general feedback, please use the questionnaire form.

SchemaAgent Server on the Internet...

The **SchemaAgent Server on the Internet** command takes you directly to the [Altova web-server](#) where you can find out about news, product updates and additional offers from the Altova team.

About SchemaAgent Server

The **About SchemaAgent Server** command shows the SchemaAgent splash screen and copyright information dialog box, which includes the version number of your product and the SchemaAgent logo. If you are using the 64-bit version of SchemaAgent, this is indicated with the suffix (x64) after the application name. There is no suffix for the 32-bit version.

Chapter 6

SchemaAgent Client

6 SchemaAgent Client

SchemaAgent Client enables you to build a SchemaAgent design, in which you [create](#) or [modify](#) IIR relationships (Imports, Includes, and Redefines) between schemas as well as relations between any of the supported file types.

In a SchemaAgent design, you can also [view relationships](#) between schemas and between a schema-based MapForce Design (MFD) file and its associated schemas. Furthermore, you can display XSLT stylesheets and WSDL files and view the relations these files have with schema files, XML instances, and MFD files. A SchemaAgent design is saved as a SAD file, which can subsequently be opened in SchemaAgent Client and edited. SchemaAgent Client has a simple, easy-to-use [graphical user interface](#), in which the supported files can easily be linked to each other using standard GUI techniques, such as drag-and-drop.

Additionally, SchemaAgent Client enables you to manage schemas and their associated files ([rename](#) them, move them, [delete](#) them, etc.) so that references to files that have been modified in this way are globally updated in related files. This functionality makes SchemaAgent Client a powerful workspace from which to manage large numbers of complex, related schemas, and edit relationships between these schemas and any of the other supported files that are linked to them in any form.

How SchemaAgent Client works

SchemaAgent Client [connects to a SchemaAgent server](#). It can either connect to the [LocalServer](#) that is installed with the SchemaAgent product, or connect to Altova's free [SchemaAgent Server](#) product. The main difference between these two servers is that LocalServer is installed on the local machine and serves clients on the same computer, while SchemaAgent Server can be installed on a network machine, serves multiple clients, and provides detailed logging information.

After connecting to the server, SchemaAgent Client retrieves information about the monitored files in the respective server's [search paths](#), and displays the folders in the search paths as a tree structure (hierarchical and flat) in the [Explorer window](#) of SchemaAgent Client. In SchemaAgent Client, you then [drag files from the tree](#) and drop them into the SchemaAgent design in the [Design window](#).

In the Design window, you can [view the composition of schemas and their associated files](#), and [build relationships between the supported files](#) in the SchemaAgent design. When you build or modify a relationship between two schemas, not only are the actual schema files updated with the new information, but all other linked schemas affected by the relationship are also updated.

6.1 Installing SchemaAgent Client

Prior to installing the software, you must download the SchemaAgent 2012 installation package from the [SchemaAgent download page](#) at the Altova website. If you have purchased Altova® MissionKit™ 2012, the SchemaAgent 2012 product is included in the package.

A local SchemaAgent server—the so-called LocalServer—will be installed as part of the SchemaAgent Client software installation. During the installation process, you will be asked whether you wish to use SchemaAgent locally (that is via the LocalServer) or via SchemaAgent Server. Your selection determines the default setting for which server the client will connect to on startup. This can always be changed using the [Extras | Connect to Server](#) menu option.

The SchemaAgent Client license must be purchased at the Altova Shop at the Altova Website. If you have purchased Altova® MissionKit™ 2012, the license for SchemaAgent Client is included in that package.

To install SchemaAgent Client:

1. Double-click the installer file to run the installation process.
2. Enter and save the licensing information so as to activate the product license.

6.2 Starting SchemaAgent Client

After you have successfully installed SchemaAgent Client, the application appears in your program list (**Start | All Programs**) of your workstation. If your license information has not yet been registered with SchemaAgent, you will be prompted for it when you try to start SchemaAgent. If you have registered a valid license, the **Connect to SchemaAgent Server** dialog box will appear.



You have two options for working with SchemaAgent:

- [Work locally](#)
- [Connect to a network server](#)

For a detailed description of the difference between these two options, please see the relevant chapters later in this documentation.

To start SchemaAgent Client:

1. Click the **Altova SchemaAgent** entry in the **All Programs** list or the **Altova SchemaAgent**  icon in the Quick Launch tray. The **Connect to SchemaAgent Server** dialog box appears.
2. Do one of the following:
 - Select `Work Locally` to connect to the LocalServer.
 - Making sure that the required server is already up and running, select `Connect to Network Server` and choose a SchemaAgent Server (running on the network) from the drop-down list.
3. Click **OK** to confirm.

To exit SchemaAgent Client:

- Select the menu option **File | Exit**.

6.3 The SchemaAgent Client User Interface

SchemaAgent Client has a graphical interface, which is organized into two broad parts:

- [Explorer window](#), which provides you with information about search paths and files available herein; and [Overview window](#), which shows what part of the active design is currently in view in the main window.
- [Design window](#), which graphically displays the structure of the supported file types, and shows existing Includes, Imports, Redefines (IIRs) between schemas, or relationships between any of the supported files, respectively.

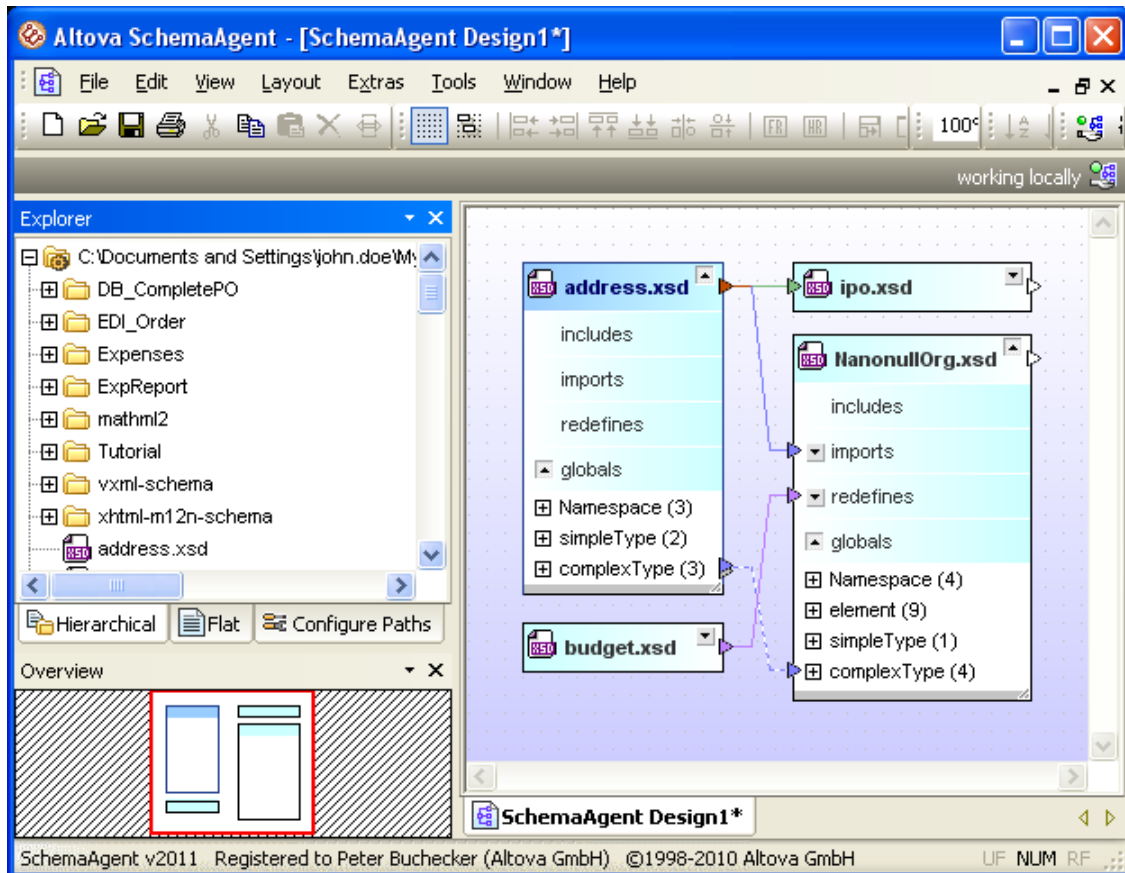

The Explorer and Overview windows can be docked under a menu bar and toolbar (see *screenshot*), or they can be freely arranged under the menu bar and toolbar. Their positions and sizes can be changed by dragging and re-sizing them.

This section provides an introduction to these broad parts of the interface. Detailed descriptions of the various interface parts follow later in this documentation.

6.3.1 Explorer Window

The Explorer window displays all search paths defined for the selected SchemaAgent Server as well as the relevant files contained herein. Depending on your installation, these search paths can be configured directly in the Configure Paths tab of the Explorer window (if you are connected to a LocalServer) or in SchemaAgent Server (if you are connected to a network-based server). Consequently, the Configure Paths tab is only visible if you are connected to a LocalServer.

Hierarchical Tab

The Hierarchical tab in a tree structure shows all files for which a [file extension has been defined](#) in all the [search paths](#) defined in the selected SchemaAgent Server (see *screenshot*). Folders that contain a supported file are colored dark yellow. Folders that contain no such files are colored light yellow.

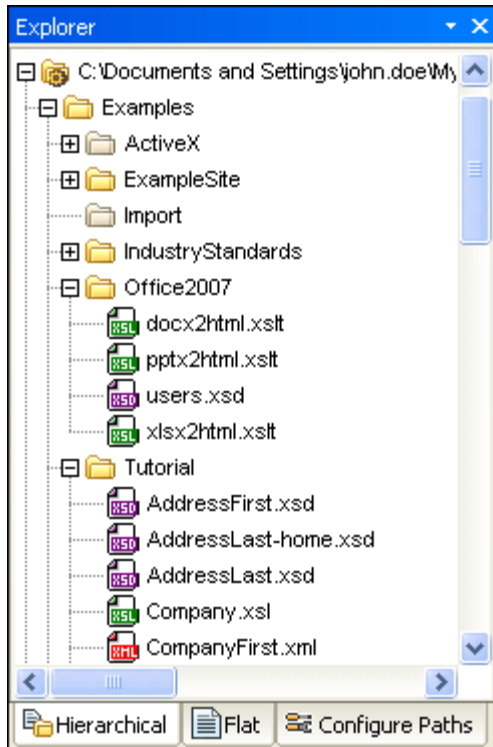

You can hide folders that contain no supported files by unselecting the option **Show Empty Folders** in the context menu.

Flat Tab

The Flat tab (see *screenshot*) displays a flat list of all monitored files in all search paths defined in the selected SchemaAgent Server, as well as all schemas in the External files folder (i.e. schemas referenced by schemas in the search paths, but which are not themselves in any search path), if such schemas exist. Each file entry is displayed with its location and its status.

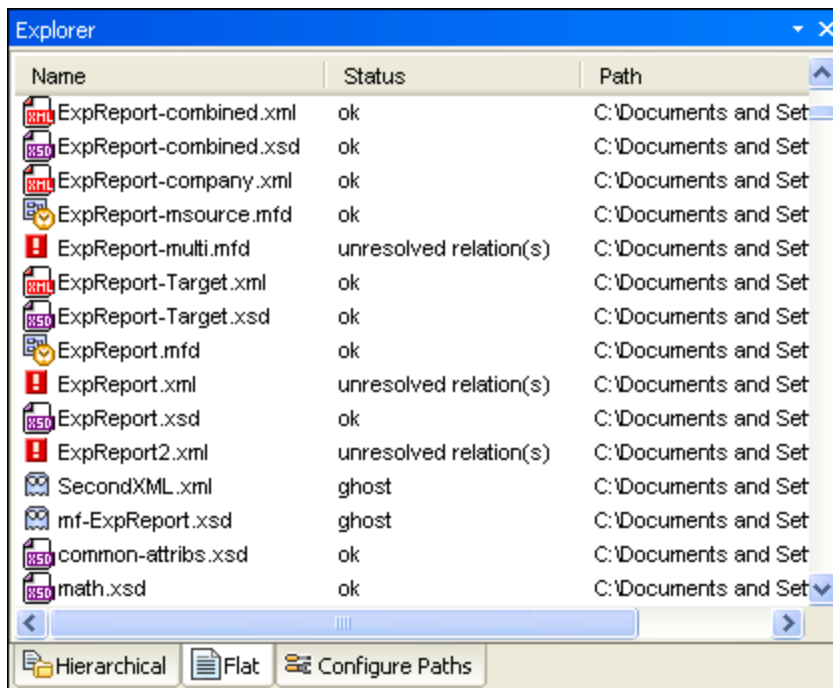

In the screenshot above, note the different icons used to indicate [ghost files](#) and files with [unresolved relations](#).

6.3.2 Overview Window

The **Overview window** serves as a navigator for big design files that occupy more space than is available in the Design window. The Overview window shows the currently displayed area in the design and you can move the focus by clicking into the rectangle and moving it to the desired location in the design file.

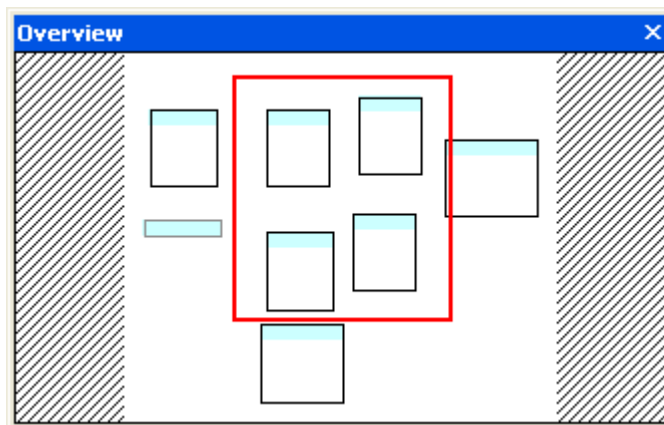

By default, the Overview window is a docked window in the bottom left part of the application. You can, however, [undock the window and drag it](#) to any position within the application.

6.3.3 Design Window

The Design window is where you view and edit the files for which you have [defined the relevant file extensions](#). Currently, the following files are supported in SchemaAgent:

- [W3C XML Schema](#)

- [MapForce Design files](#)
- [XML instance files](#)
- [XSL/XSLT stylesheets](#)
- [Web Service Description Language \(WSDL\) files](#)

You can drag files from the Explorer window and drop it onto the Design window to get a graphical illustration of the files and their existing Includes, Imports, and Redefines (IIRs). The files can be [aligned](#) and [sorted](#) according to your needs, or [removed](#) from the design again. It is possible to [recreate a deleted file](#) and to [correct reference paths](#) to files that are not existing on the specified location.

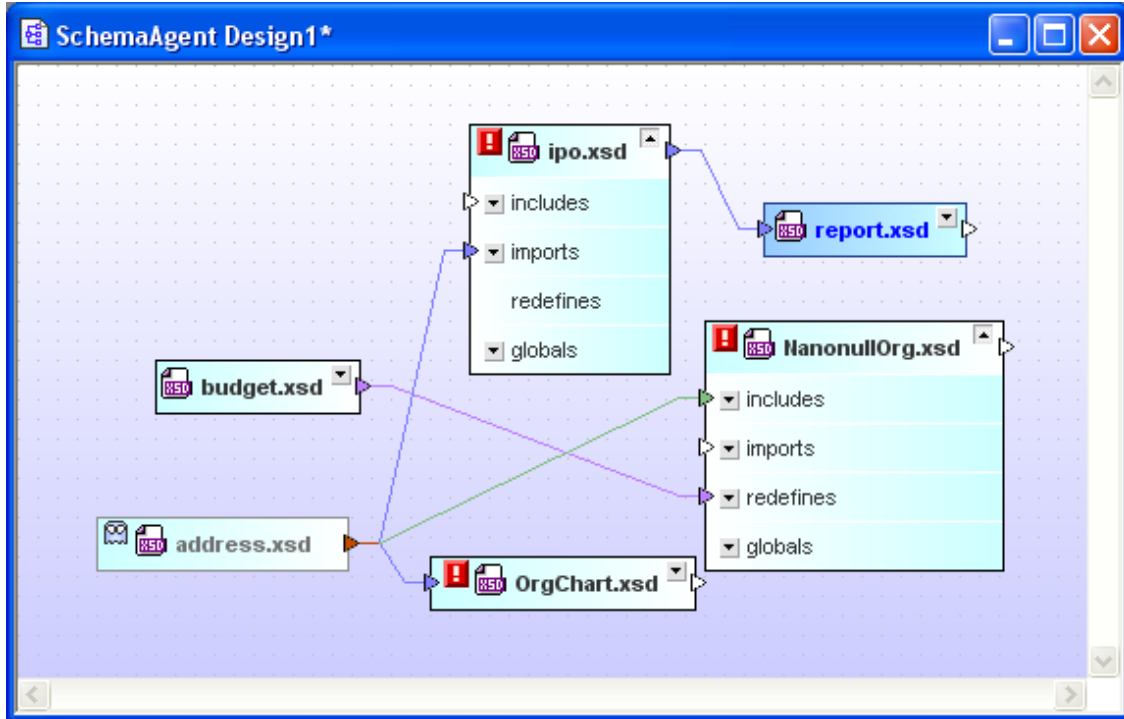

Includes, Imports, and Redefines between schemas or schemas and MFD files, respectively, are illustrated with customizable colored lines. IIRs can be [edited](#) and [added](#) using drag-and-drop and you can [save](#) each design as SAD file for late re-use. You can open several designs in the Design window, each of them is displayed in a separate Design tab.

6.3.4 Menu Bar, Toolbars, and Status Bar

The **menu bar** contains the various application menus. The following conventions apply:

- If commands in a menu are **not** applicable, they are unavailable.
- Some menu commands pop up a sub-menu with a list of additional options. Menu commands with sub-menus are indicated with a right-pointing arrowhead to the right of the command name.
- Some menu commands pop up a dialog that prompts you for further information required to carry out the selected command. Such commands are indicated with an ellipsis (...) after the name of the command.
- To access a menu command, click the menu name and then the command. If a sub-menu is indicated for a menu item, the submenu opens when you mouseover the menu item. Click the required sub-menu item.
- A menu can be opened from the keyboard by pressing the appropriate key combination. The key combination for each menu is **Alt+KEY**, where **KEY** is the underlined letter in the menu name. For example, the key combination for the **File** menu is **Alt+F**.

- A menu command (that is, a command in a menu) can be selected by sequentially selecting (i) the menu with its key combination (see previous point), and then (ii) the key combination for the specific command (**Alt+KEY**, where **KEY** is the underlined letter in the command name). For example, to open a file (**File | Open**), press **Alt+F** and then **Alt+O**.
- Some menu commands can be selected **directly** by pressing a special **shortcut** key or key combination (**Ctrl+KEY**). Commands which have shortcuts associated with them are indicated with the shortcut key or key combination listed to the right of the command. For example, you can use the shortcut key combination **Ctrl+N** to create a new file; the shortcut key **F2** to rename a file or folder in the Explorer window.

Toolbars

The **toolbars** contain buttons that are shortcuts for commands found in the menus. The name of the command appears when you place your mouse pointer over the button. To execute the command, click the button.

Toolbar buttons are arranged in groups. In the [Tools | Customize | Toolbars](#) dialog, or when right-clicking into the toolbar and selecting **Customize**, you can specify which toolbar groups are to be displayed. In the GUI, you can also drag toolbar groups by their handles (or title bars) to alternative locations on the screen. Double-clicking the handle causes the toolbar to undock and to float; double-clicking its title bar causes the toolbar to dock at its previous location.

Status Bar

The Status Bar is located at the bottom of the application window and displays (i) status information about the loading of files, and (ii) information about menu commands and command shortcuts in the toolbars when the mouse cursor is placed over these. If you are using the 64-bit version of SchemaAgent, this is indicated in the status bar with the suffix (x64) after the application name. There is no suffix for the 32-bit version.

6.3.5 Arranging the Information Windows

All information windows can be docked/undocked by double-clicking the title bar.

Context Menu

The context menu can be accessed by right-clicking a window's title bar or by clicking the little arrowhead in the upper right part of the window.

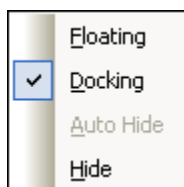

Click the required option to cause that window to float, be docked, or be hidden.

Drag-and-drop

You can drag a window by its title bar and place it at a desired location.

Additionally, you can dock the window in another window or in the interface using placement controls that appear when you drag a window:

- When you drag a window over another window, a circular placement control appears (see *screenshot below*). This control is divided into five placement sectors. Releasing the mouse key on any of these sectors docks the dragged window into the respective sector of the target window. The four arrow sectors dock the dragged window into the respective sides of the target window. The center button docks the dragged window as

a tab of the target window. You can also dock a window as a tab in another window by dragging it to the tab bar and dropping it there.

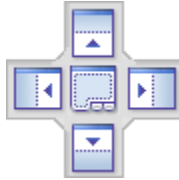

- When you drag a window, a placement control consisting of four arrows appears. Each arrow corresponds to one side of the Design window. Releasing a dragged window over one of these arrows docks the dragged window into one side of the Design window.



You can also double-click the title bar of a window to toggle it between its docked and floating positions.

6.4 Connecting to a Server

In order to use SchemaAgent Client, you must connect the application to a server first. When you start SchemaAgent Client, the  icon is displayed in the upper right corner of the application and the **Connect to SchemaAgent Server** dialog box pops up.



You have two options to use SchemaAgent Client:

- [Work locally](#): This will start a standalone LocalServer on your PC which you can configure from within SchemaAgent Client
- [Connect to network server](#): This will connect to a network-based SchemaAgent Server which must already be running and allows for several users being connected. To configure SchemaAgent Server, you have to open the server application and this configuration is available to all connected clients.

If a SchemaAgent server connection already exists, you have to close this connection before making a new connection.

To connect to a server:



1. Select the menu option **Tools | Connect to Server** or click the **Connect to Server**  icon in the Extras toolbar.
The **Connect to SchemaAgent Server** dialog box opens.
2. Do one of the following:
 - Select `Work locally` to start and connect to the standalone LocalServer.
The `Configure Paths` tab is added to the Explorer window.
 - Select `Connect to network server` and choose a SchemaAgent Server to connect to from the drop-down list.
The search paths are displayed in the Explorer window.
3. Click **OK**.

To close a connection:

- Click the SchemaAgent server  icon in the system tray (at the bottom right of your screen) and select the **Shutdown** command.

6.4.1 Working Locally

If you choose to connect to your local standalone server, the LocalServer will be started automatically and the `Configure Paths` tab is added to the Explorer window. The

 icon is displayed in the upper right corner of the application and the system tray shows the LocalServer  icon.

You can define in the Options that the LocalServer be started automatically when the user logs in.

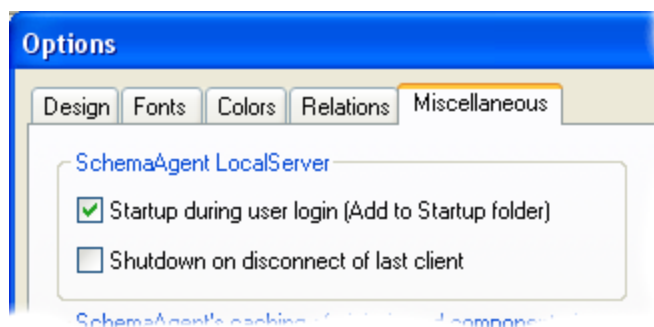

If the `Startup during user login (Add to Startup folder)` check box is activated, the `SchemaAgentLocalServer.exe` is added to the Windows Startup folder and the LocalServer will be started automatically each time the user logs in to Windows.

To start LocalServer automatically:

1. Select the menu option **Tools | Options** and go to the **Miscellaneous** tab.
2. In the SchemaAgent LocalServer group box, activate the `Startup during user login (Add to Startup folder)` check box.
3. Click **OK**.
The next time a user logs in to Windows, the SchemaAgent LocalServer will be started automatically.

To shut down the LocalServer:

- Click the LocalServer  icon in the system tray (at the bottom right of your screen) and select **Shutdown SchemaAgent LocalServer**.

6.4.2 Connecting to a Network Server

If you have set up a network server you wish to connect to, select the `Connect to network server` option and choose the appropriate server from the drop-down list. Please note that the server must already be running (i.e., the SchemaAgent Server  icon must be displayed in the system tray) in order for SchemaAgent Client to be able to connect to. The

 icon is displayed in the upper right corner of the application and indicates the name of the server you are connected to. The search paths can be configured directly in SchemaAgent Server and are valid for all connected clients. Therefore, no Configure Paths tab is available in the Explorer window.

6.5 Working with the Explorer

The Hierarchical and Flat tabs of the Explorer window show all the [defined search paths](#) as well as the files with the [defined file extensions](#). In the Hierarchical tab, you can furthermore [create](#) a new, or [rename](#) or [delete](#) an existing file or folder; or you can move files and folders to other positions under each path entry; and [recreate ghost files](#).

All of the actions in the Explorer window are performed by means of the context menu or by using drag-and-drop. The content of the context menu depends on the file, folder, or area from where it is called. The following menu appears if you right-click anywhere into the blank area within the Explorer window:

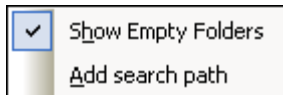

- **Show Empty Folders:** This commands toggles on and off the display of folders that do not contain any files with [file extensions defined](#) in the Configure Paths tab.
- **Add search path:** This command is only available if you are connected to the LocalServer. It changes to the Configure Paths tab and opens the **Add/Edit search path** dialog box where you can define the settings for a new search path.

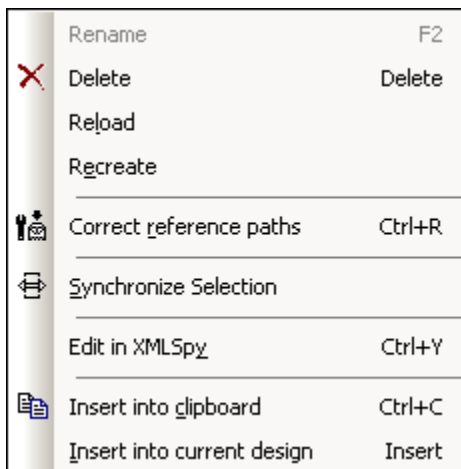

- **Rename (F2):** [Renames](#) the selected file or folder.
- **Delete (Delete):** [Deletes](#) the selected file or folder from the file system.
- **New:** Opens a sub-menu from where you can choose to [create a new file or directory](#).

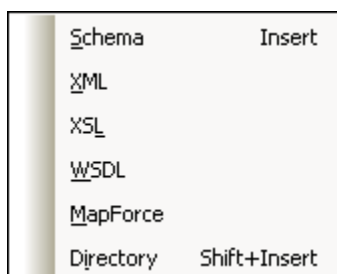

- **Reload:** Reloads the selected file. You can also select several files and choose the **Reload** command to reload the files in one single step.

- **Recreate:** This command is only available if you have selected at least one ghost file. It [creates a new rudimentary file](#) with the name of the ghost file.
- **Correct reference paths (Ctrl+R):** This command is only available if you have selected at least one file with a reference to a ghost file. It opens the **Correct reference path** dialog box where you can search for the ghost file in different locations.
- **Synchronize Selection:** If you have a design open in the Design window, this command selects the same files in the Design window as are selected in the Explorer.
- **Edit files in MapForce (Ctrl+M):** Opens the selected MFD file in MapForce for editing (provided that you have installed MapForce).
- **Edit files in XMLSpy (Ctrl+Y):** Opens the selected file in XMLSpy for editing (provided that you have installed XMLSpy).
- **Insert files into clipboard (Ctrl+C):** Copies the selected files to the clipboard.
- **Insert files into current design (Insert):** Adds the selected files to the design that is currently open in the Design window.

Please note: If actions, such as renaming or deleting, or IIR changes (Includes, Imports, Redefines), that affect any file referencing the changed file are carried out on a file, all relationships of any file referencing the modified file or folder are **immediately** and automatically updated, and, in some cases, the changes are propagated through the search paths.

Warning: Any change made in the Hierarchical and Flat tabs automatically affects any file referencing the changed file. Since there is no Undo command available for these actions, it is highly recommended that you have a working backup system or use source control software when working with SchemaAgent Client.

6.5.1 Creating Files and Folders

When you create a new file or folder in the Explorer window, a rudimentary `untitled` and having the respective file extension, is created in the folder that currently has the focus in the Hierarchical tab and a corresponding entry is created in the Hierarchical tab.

If you open a new **schema** in XMLSpy, it will look like this:

```
<?xml version="1.0" encoding="UTF-8" ?>
<xs:schema xmlns:xs="http://www.w3.org/2001/XMLSchema"
  elementFormDefault="qualified"
  attributeFormDefault="unqualified" />
```

A new **XML** file has the following content:

```
<?xml version="1.0" encoding="UTF-8" ?>
<root />
```

A new **XSLT** file will look like this:

```
<?xml version="1.0" encoding="UTF-8" ?>
<xsl:stylesheet version="2.0"
  xmlns:xsl="http://www.w3.org/1999/XSL/Transform"
  xmlns:fo="http://www.w3.org/1999/XSL/Format"
  xmlns:xs="http://www.w3.org/2001/XMLSchema"
  xmlns:fn="http://www.w3.org/2005/xpath-functions" />
```

A file with the following content is created if you choose to add a new **WSDL 1.1** file:

```
<?xml version="1.0" encoding="UTF-8" ?>
<wsdl:definitions
  xmlns:wsdl="http://schemas.xmlsoap.org/wsdl/"
  xmlns:soap="http://schemas.xmlsoap.org/wsdl/soap/"
  xmlns:http="http://schemas.xmlsoap.org/wsdl/http/"
  xmlns:xs="http://www.w3.org/2001/XMLSchema"
  xmlns:soapenc="http://schemas.xmlsoap.org/soap/encoding/"
  xmlns:mime="http://schemas.xmlsoap.org/wsdl/mime/"
  xmlns:tns="http://new.webservice.namespace"
  targetNamespace="http://new.webservice.namespace" />
```

A file with the following content is created if you choose to add a new **WSDL 2.0** file:

```
<?xml version="1.0" encoding="UTF-8" ?>
<wsdl:description
  targetNamespace="http://new.webservice.namespace"
  xmlns:wsdl="http://www.w3.org/ns/wsdl"
  xmlns:wsoap="http://www.w3.org/ns/wsdl/soap"
  xmlns:whttp="http://www.w3.org/ns/wsdl/http"
  xmlns:xs="http://www.w3.org/2001/XMLSchema"
  xmlns:tns="http://new.webservice.namespace" />
```

When a new folder is created, an empty folder called `new folder` is physically created in the folder that currently has the focus in the Hierarchical tab and an entry for this folder is created in the Hierarchical tab.

Please note: If you have deselected the **Show Empty Folders** option in the Explorer context menu, the new folder, because it contains no schemas, will not be displayed in the Hierarchical tab.

To create a new file or folder in the Explorer window:

1. In the Hierarchical tab, select the folder where you want to create the file or folder.
2. Do one of the following:
 - Right-click and select **New | Schema file** from the context menu, or press the **Insert** key to create a new schema.
 - Right-click and select **New | XML file** from the context menu to create a new XML file.

- Right-click and select **New | XSL file** from the context menu to create a new XSLT file.
- Right-click and select **New | WSDL 1.1 file** from the context menu to create a new WSDL 1.1 file.
- Right-click and select **New | WSDL 2.0 file** from the context menu to create a new WSDL 2.0 file.
- Right-click and select **New | MapForce design** from the context menu to create a new MFD file.
- Right-click and select **New | Folder** from the context menu, or press **Shift+Insert** to create a new sub-folder.

3. Enter a descriptive name and press **Enter**.

6.5.2 Renaming Files and Folders

When you rename a file in the Explorer window, SchemaAgent automatically corrects any references to the changed name and updates the display in the Design window if the renamed item is contained in the currently open design.

Please note: Although you can change the file extension when renaming files, this will not change the file type and the file may become unusable if you ignore the warning that is displayed by SchemaAgent.

To rename a file or folder:

1. In the Explorer window, select the file or folder and do one of the following:
 - Right-click and select **Rename** from the context menu.
 - Press **F2**.
2. Change the name as desired. Any references to the changed name are automatically updated.

6.5.3 Deleting Files and Folders

The Explorer window allows you to physically delete files or folders from the hard disk.

Please note: Deleted files are not placed in the Windows Recycle Bin, and this step cannot be undone.

If the deleted file is present in a Design tab, it is represented as an **unknown file** (see *screenshot*); since the file is physically deleted, SchemaAgent Server has no more knowledge of it. SchemaAgent Client, however, still has an entry for it in the Design window, where it receives a yellow alert icon.



To delete a file or folder:

1. In the Explorer window, select a file or folder and do one of the following:
 - Right-click and select **Delete** from the context menu.
 - Press the **Delete** key.
2. Click **Yes** in the message box to confirm the deletion.

6.5.4 Editing Files

Apart from the definition of Includes, Imports, and Redefines, files cannot be directly edited in SchemaAgent. However, the context menus of the Explorer window and the Design window provide options to edit the selected files in XMLSpy or MapForce. Please note that these options are only available if the respective programs are installed on your computer.

To edit a file in XMLSpy:

- In the Design window or in the Explorer window, select the file you want to edit and do one of the following:
 - Right-click and select **Edit in XMLSpy** from the context menu.
 - Press **Ctrl+Y**.

The selected file is opened in XMLSpy if XMLSpy is installed.

To edit an MFD file in MapForce:

- In the Design window or in the Explorer window, select the MFD file you want to edit and do one of the following:
 - Right-click and select **Edit in MapForce** from the context menu.
 - Press **Ctrl+M**.

The selected MFD file is opened in MapForce if MapForce is installed.

6.6 Viewing Files in the Design Window

The Design window offers several grid and zoom options that can be configured to facilitate an optimal display of [XML schemas](#), [MapForce Design files](#), [XML files](#), [XSL/XSLT stylesheets](#), [WSDL files](#), and [IIR relations](#).

Showing or hiding the grid

Displaying the grid in the design window can serve as an aide for properly aligning the file boxes. You can toggle the grid display on and off separately for each individual Design window.

To toggle the grid in a SchemaAgent Design window on and off:

Do one of the following:

- Select the menu option **Layout | Show Grid**.
- Right-click anywhere in the design pane and select **Align | Grid active** from the context menu.
- Press **Alt+G**.
- Choose the **Enable/Disable grid**  icon from the Alignment toolbar.

Aligning file boxes on grid

When the grid is displayed, you can align the top and left edges of file boxes on the grid.

To align file boxes on the grid:

1. [Turn the grid display on](#) if it is not currently displayed.
2. Select the file boxes you want to align.
3. Do one of the following:
 - Select the menu option **Layout | Align on Grid**.
 - Right-click anywhere in the design pane and select **Align | On Grid** from the context menu.
 - Choose the **Align on Grid**  icon from the Alignment toolbar.

Zooming in and out

The zoom of a design can be adjusted individually for each Design window. SchemaAgent provides the **Zoom** sub-menu in the **Layouts** menu as well as the Zoom toolbar to this aim.

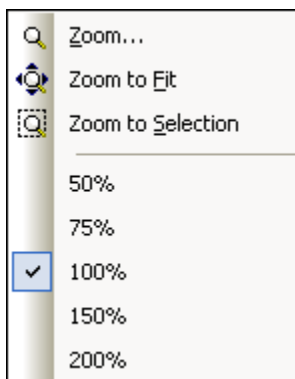

When you select the **Zoom...** command from the menu or click the **Show Zoom dialog**  icon in the Zoom toolbar, the **Zoom** dialog box opens where you can adjust the zoom by using the slider.

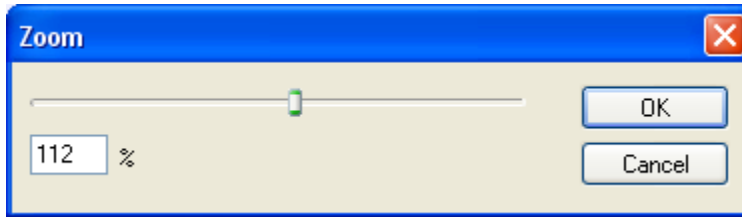

In addition, you can zoom in and out of a design view by scrolling (with the scroll-wheel of the mouse) while keeping the **Ctrl** key pressed. This enables you to magnify and reduce the size of file boxes in a particular design view.

To zoom in or out of a design view:

1. Do one of the following:
 - Select the menu option **Layout | Zoom** and choose **Zoom** from the sub-menu.
 - Choose the **Show Zoom dialog**  icon from the Zoom toolbar.
The **Zoom** dialog box appears.
2. In the **Zoom** dialog box, do one of the following:
 - Adjust the zoom factor using the slider.
 - Enter a specific zoom factor in the box below the slider.
3. Click **OK**.

Alternatively, you can also select a zoom factor from, or enter it in, the drop-down list in the Zoom toolbar.

To make all file boxes fit in a Design window:

- Do one of the following:
 - Select the menu option **Layout | Zoom** and choose **Zoom to fit** from the sub-menu.
 - Choose the **Zoom to Fit**  icon from the Zoom toolbar.
The zoom factor is adjusted so that all file boxes in the Design window become visible.

To zoom to a selection:

1. Select one or more file boxes.
2. Do one of the following:
 - Select the menu option **Layout | Zoom** and choose **Zoom to selection** from the sub-menu.
 - Choose the **Zoom to Selection**  icon from the Zoom toolbar.

The zoom factor is adjusted so that the selected file boxes in the Design window become visible.

6.6.1 Creating and Saving Designs

In the [Design window](#), you can open multiple design tabs. Each design tab contains a SchemaAgent design, in which you can graphically [design and manage the relationships](#), that is IIRs (Includes, Imports, or Redefines), between an unlimited number of W3C XML schemas, and also display the relationships between XSLT stylesheets, Web Services Description (WSDL) files, MapForce Design (MFD) files or XML files and their associated schemas. In this way, you can organize schemas (and MFD or XML files) into collections of related files.

Saving designs

A SchemaAgent design can be saved as a SAD file for editing at a later time. This is useful if you wish to modify relationships in the SchemaAgent design at a later time. Note that a set of files (and, therefore, their relationships) can be contained in multiple SchemaAgent designs. Any IIR relationship created in a SchemaAgent design is immediately propagated to the respective files as soon as the relationship is created.

To open a new SchemaAgent design window:

- Select the menu option **File | New (Ctrl+N)** or click the **New**  button in the Standard toolbar.
A new Design window appears.

To open an existing SchemaAgent design (file):

1. Select the menu option **File | Open (Ctrl+O)** or click the **Open**  button in the Standard toolbar.
The **Open** dialog box appears.
2. In the **Open** dialog box, select the desired file and click **Open**.

To open a recently used design file:

- Select the menu option **File** and click one of the recently opened files that are displayed in the lower part of the menu.

To save a design:

1. Select the menu option **File | Save (Ctrl+S)** or click the **Save**  button in the Standard toolbar.
Alternatively, select the menu option **File | Save As...** if you want to save the file under a different file name or path.
2. If the design has not been saved before, choose a path and enter a file name in the **Save As** dialog box.

To close the currently active design file:

1. Select the SchemaAgent design window for the design file you want to close.
2. Select the menu option **File | Close**.

6.6.2 Inserting Files and Folders

XML schemas, MFD, XML, XSLT, and WSDL files are added to a design either using the context menu in the Explorer or by dragging them from the Explorer window into a Design window. Each file is displayed as a file box, existing relationships between files are represented with colored lines.

When inserting files into a design window, you have several options to do so:

- Selecting one or several files in the Explorer, then right-clicking and choosing **Insert into current design** from the context menu.
- Dragging the file(s) from the Explorer window using the left mouse button will insert only the selected file(s).
- When dragging the file(s) from the Explorer window using the right mouse button, a popup will appear upon releasing the mouse button:

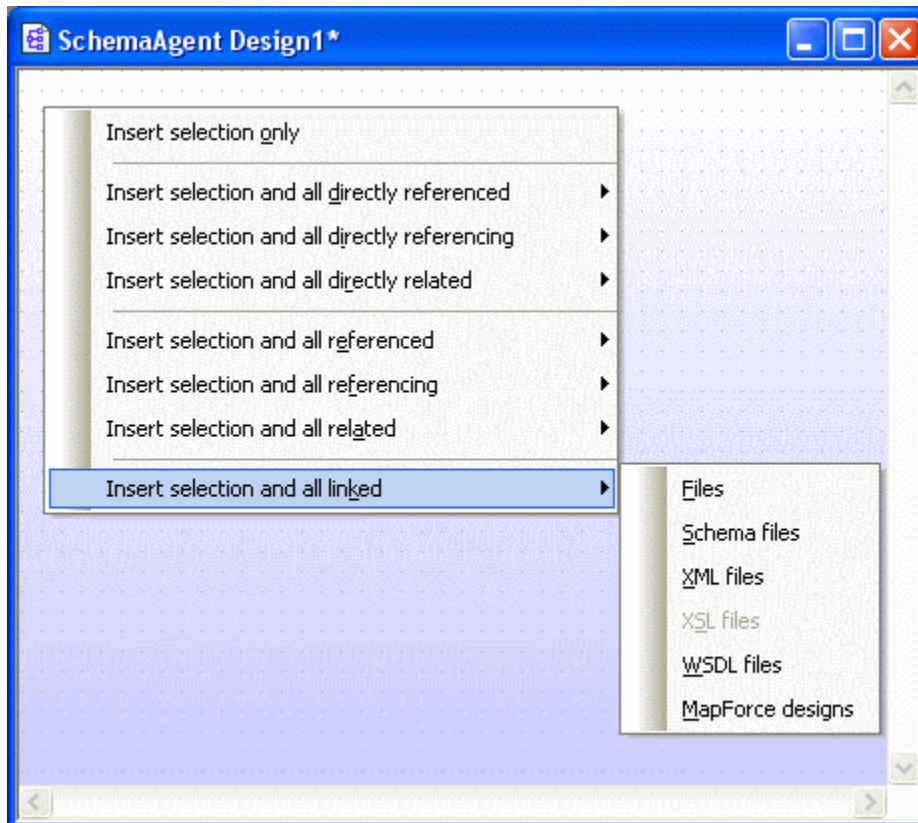

In addition to inserting only the selected file(s), you can now also choose to insert all files that are directly or indirectly referenced by the selected file(s). Each of the options opens a sub-menu where you can further restrict your choice to a single file type (XSD, MFD, XML, XSLT, or WSDL) or select all files.

- Selecting a folder in the Explorer window and dragging it into a design window will insert all relevant files that are contained in the selected folder.
- Expanding a file box in the Design window, right-clicking an included or imported file and selecting **Insert into current design** will add a file box for this file to the design.

To insert files or folders into a design:

- In the Explorer window, do one of the following:
 - To insert one or several individual files, select the desired files and drag them into a Design window using the left mouse button.
 - To insert all files contained in a folder, drag the folder into a Design window.

The files or the files contained in the dragged folders, respectively, appear in the Design window. Alternatively, you can also select one or several files or folders and choose

Insert into current design from the context menu or press **Insert**.

- To insert the file(s) as well as all directly or indirectly referenced files, select one or more files, drag them into a Design window using the right mouse button and select the desired option from the context menu that appears.

The selected file(s) as well as the respective referenced files appear in the Design window.

- To select a file box for a file that shows up as related file in a different file's box, right-click that file in the relevant section of the file box and choose **Insert into current design** from the context menu or press **Insert**.

6.6.3 Inserting Related Files

Once you have dragged a schema, MFD, or XML file into a Design window, you can use the context menu to add all the related files to the design. Several options are available in the **Insert** sub-menu:

- All directly referenced
- All directly referencing
- All directly related
- All referenced
- All referencing
- All related
- All linked

Each of these menu options opens a sub-menu, from where you can choose **Files**, **Schema files**, **XML files**, **XSLTL files**, **WSDL files**, or **MapForce designs**. The **Files** option will insert all files that meet the requirements, the remaining options will restrict the inserted files to the chosen file type.

Note that these options are also available when you [insert a file into a Design window](#) by dragging it from the Explorer window using the right mouse button.

To insert related underlying files into the design:

1. Right-click the title bar of a file box and select one of the following options from the **Insert** sub-menu of the context menu:
 - All directly referenced
 - All directly referencing
 - All directly related
 - All referenced
 - All referencing
 - All related
 - All linked
2. From the sub-menu choose either **Files**, to insert all files or choose from among one of the available file types.

Directly Related Files

Files that are directly related are displayed with an uninterrupted connector line between them in a Design window.

Directly referenced files

These are files that are directly referenced with an IIR statement. For example, if Schema A has an Include statement that references Schema B, then Schema B is directly referenced by Schema A.

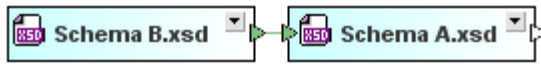

An XML file can reference one or several XML schemas or XSLT stylesheets.

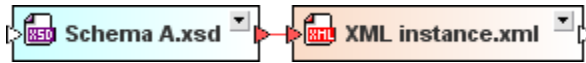

An XSLT file can import XML schemas, and import or include other XSLT files. What is more, it can also have one or more inline schemas defined. All these relations are direct references.

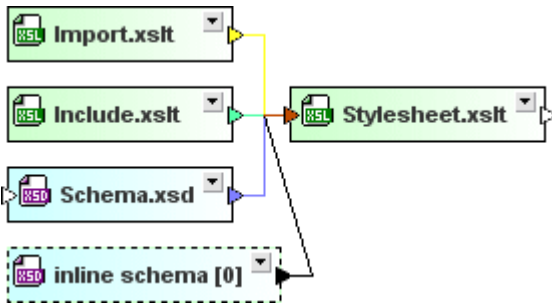

Other imported WSDL files and XML schemas as well as any inline schemas that may exist are directly referenced by WSDL files.

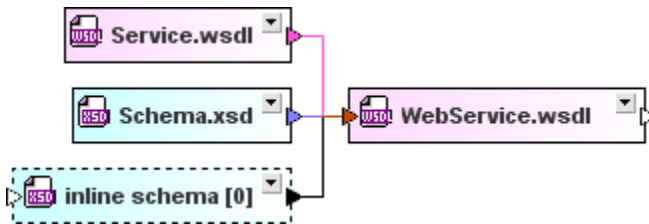

An MFD file directly references its source and target schemas as well as XML instances.



Directly referencing files

In this case, the file to be inserted references the selected file with an IIR statement, that is, the selected file is referenced by the file to be inserted. In our example above, Schema A is directly referencing Schema B and Target.xsd is directly referencing Design File.mfd.

All directly related

This option applies to both directly referenced and directly referencing files.

Indirectly Related Files

When files are indirectly related to each other, no direct connection is visible between the file boxes. The relation is established via a third file box with a direct relation to these files.

Referenced files

These are files that are directly as well as indirectly referenced. For example, if Schema A has an Include statement that references Schema B, and Schema B has an Include statement that references Schema C, then (i) Schema B is directly referenced by Schema A, (ii) Schema C is directly referenced by Schema B, and (iii) Schema C is indirectly referenced by Schema A (since Schema A references Schema B, which in turn references Schema C).

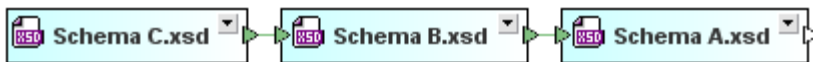

If a schema that is directly referenced by an **XML file** references another schema (e.g. Schema B is imported by Schema A), this schema (Schema B in our example) is said to be indirectly referenced by the XML file.

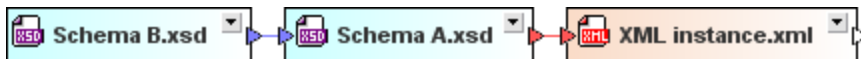

Any schemas and XSLT files that are included or imported in files directly referenced by **XSLT stylesheets** are said to be indirectly referenced by these stylesheets. So, in the example below, Catalog.xsd is indirectly referenced by Stylesheet.xslt because it is imported in Import.xslt which is included in Stylesheet.xslt.

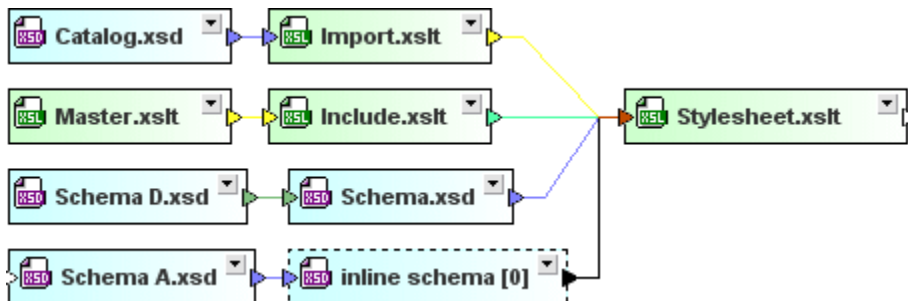

WSDL files can contain (inline) schemas or and these (inline) schemas can include, import, or redefine other schemas. Any schema that is included, imported, or redefined in such a schema (like Schemas Import, D, and Catalog in the example below), is indirectly referenced by the WSDL file.

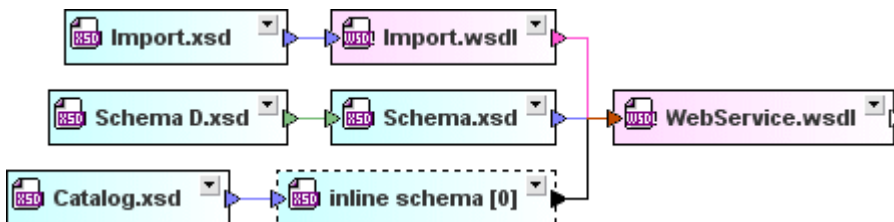

In the case of an **MFD file**, in addition to the directly referenced source and target schemas, any schema that the source schema references or the target schema is referenced by (Schema Z in our example) is considered to be referenced by the MFD file.

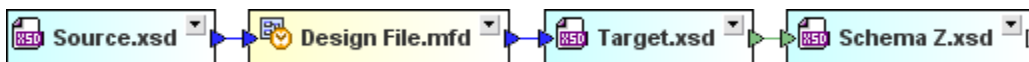

Referencing files

Files that are directly as well as indirectly referencing the selected file.

All related

This option applies to both referenced and referencing files with a direct as well as indirect reference.

Linked Files

These are schemas that are directly and indirectly referenced, as well as schemas that are linked to any of the directly or indirectly referenced schemas in any way. For example, if we extend our previous example so that Schema Z includes Schema B, then Schema Z is linked to Schema A (because Schema A includes Schema B). Further, if Schema Z, which is linked to Schema A, is either the target or source schema of an MFD file, then that MFD file is

considered to be linked to Schema A. Web Service.wsdl is also linked to schema A because it uses Schema Z which includes Schema B and Schema A includes Schema B. Stylesheet.xslt is linked to Schema A because it is referenced by XML instance.xml, which in turn references Schema A.

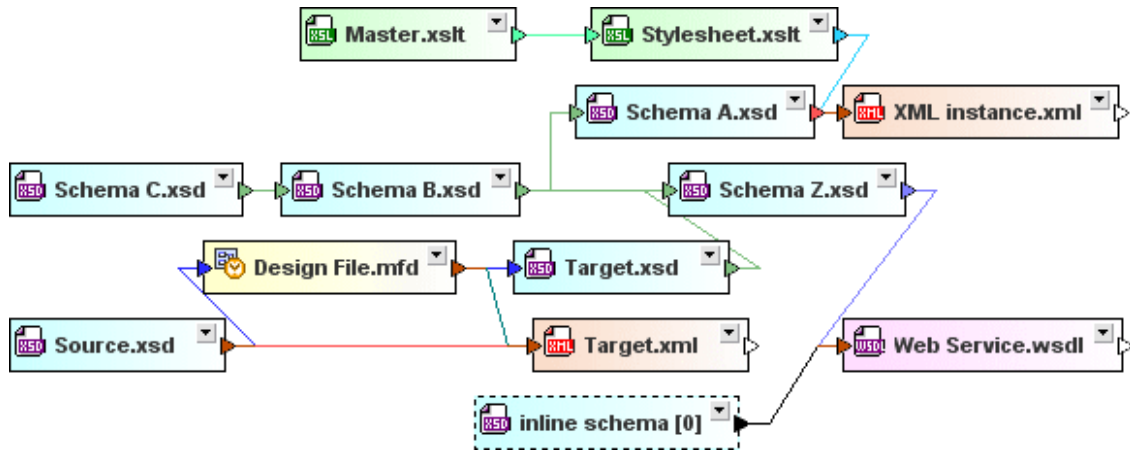

6.6.4 Arranging Files in Designs

After you have [inserted files](#) into a Design window, you can arrange the file boxes on the design pane by dragging them to the desired location with the mouse. For designs containing a large number of files, the [Overview window](#) provides an overview so that you can see at a glance where in the design the visible part is located.

You can resize boxes by dragging box borders as well as expand or collapse them by clicking the expand  button in the title bar of boxes.

Tree structures within boxes can be expanded and collapsed individually by clicking the plus and minus symbols to the left of tree entries. When you right-click an item in a file box, the context menu that appears (see *screenshot below*) provides commands to expand or collapse tree levels, and to size the file box to fit.

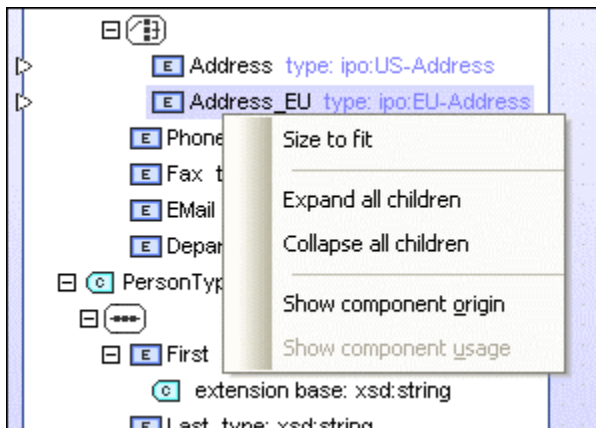

You can expand or collapse all children of the selected item, or expand or collapse the entire tree in which the selected item is. The **Size to fit** command resizes file boxes to show all visible items without the file box having any scrollbar.

Navigating within the Design window

Within a Design window, you can navigate from one file box to the next using the cursor keys (Up, Down, Left, Right).

To expand or collapse a file box:

- Click the expand  button in the title bar or a file box.

To expand or collapse the tree structure in a file box:

Do one of the following:

- To expand or collapse individual items, click the plus or minus icons to the left of the item.
- To expand or collapse an individual item and its children, right-click the item and select **Expand all children** or **Collapse all children** from the context menu.
- To expand or collapse all items in a file box, right-click any item in the box and select **Expand all** or **Collapse all** from the context menu.

To show all expanded items in a file box:

- Right-click anywhere in an expanded section of the file box and select **Size to fit** from the context menu.

6.6.5 Viewing Schemas

In the Design window, each schema is displayed as a box, which can be expanded and collapsed. When schemas are inserted into a design, they appear as collapsed schema boxes.



In the above schema, note that—apart from the arrowhead in the expand  button—there are two more arrowheads. The arrowhead on the left indicates that this schema either includes, imports, or redefines other schemas or schema components. By expanding the schema box, you can determine exactly which other schemas or schema components are included, imported, or redefined. The arrowhead on the right is used to [create an IIR](#) that includes, imports, or redefines this schema or its schema components in other schemas.

Minimized schema boxes can be expanded (*see screenshot below*) by clicking the button in the title bar. They expand into four sections: Includes, Imports, Redefines, and Globals. In the screenshot below, the arrowheads at the left of the Imports and Redefines sections indicate that this schema imports at least one schema and redefines at least one schema component from an external schema.



Each section of the schema box can be further expanded if a sub-structure is present (indicated by the expand  button in the upper right corner of the schema box), and this sub-structure is displayed as a freely expandable tree structure of IIRs and global components.

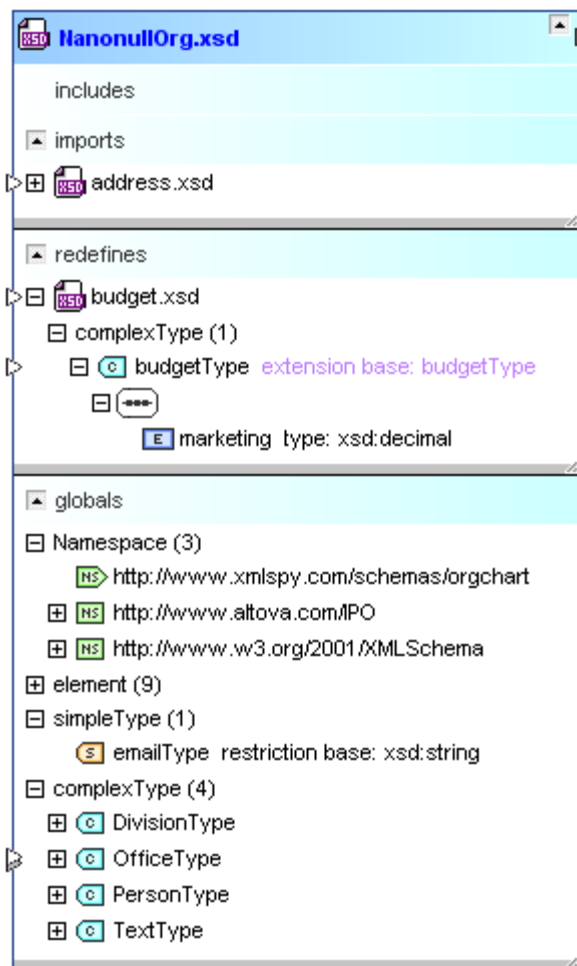

The arrowheads move depending on the level of detail that you display by expanding the individual sections. Note the double arrowhead next to the `OfficeType` complexType indicating that two relationships are contained in this section.

To view a schema:

1. Drag-and-drop the schema you want to view from the Explorer window onto a Design window or use the context menu to add the file to the current design.
2. Optionally, expand the sub-sections to view detailed information on IIRs or components.

6.6.6 Viewing XML instance files

XML files that are inserted into a design are displayed as collapsed XML boxes.

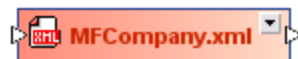

The design of an XML box is basically identical to the design of a [schema box](#). The box can be expanded and then shows three sub-sections. In the screenshot below, the arrowhead at the left of the Schema section indicates that this XML instance has an XML schema defined.

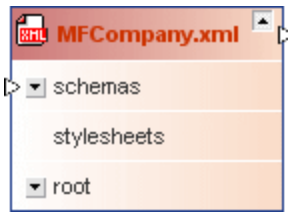

You can further expand the Schema and the Root sections of the XML box to see which XML schema and which namespaces are defined for the XML file.

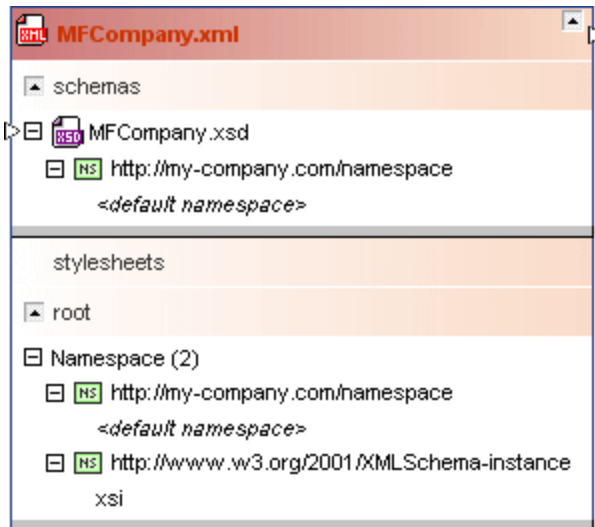

If the XML instance has also an XSLT stylesheet defined, you can expand the stylesheets section and view information on the XSLT file.

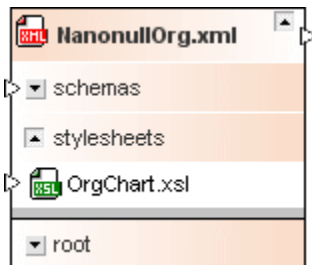

To view an XML file:

1. Drag-and-drop the XML file you want to view from the Explorer window onto a Design window or use the context menu to add the file to the current design.
2. Optionally, expand the sub-sections to view detailed information on schemas, stylesheets, or namespaces.

6.6.7 Viewing XSL/XSLT stylesheets

An XSLT stylesheet appears as a collapsed XSLT box when it is inserted into a Design window.

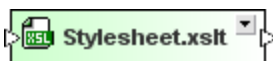

The expanded box shows five sub-sections for imported or included XSLT files, imported schemas, inline schemas, and stylesheets.



Expanding the sub-sections displays the names of the imported or included files, and the namespaces that are defined for the stylesheet.

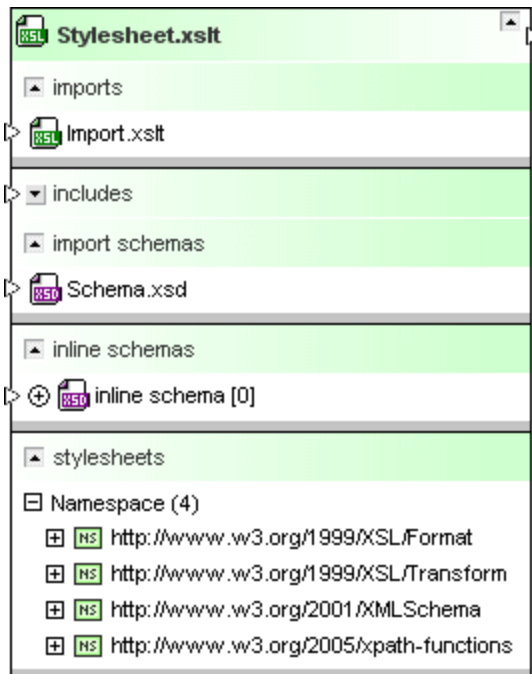

Please note: Since stylesheet files of version 1.0 support neither importing schemas nor inline schema, the relevant sections are not displayed in the file boxes of these files. The version of a stylesheet file is displayed in the [Quick Information](#) of a file box.

To view an XSLT file:

1. Drag-and-drop the XSLT file you want to view from the Explorer window onto a Design window or use the context menu to add the file to the current design.
2. Optionally, expand the sub-sections to view detailed information on imports or includes, imported or inline schemas, or namespaces.

6.6.8 Viewing WSDL files

When you add a WSDL file to a Design window, it appears as collapsed WSDL file box.

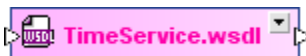

The expanded box shows four sub-sections for imported WSDL or XML schema files, inline schemas, and definitions.

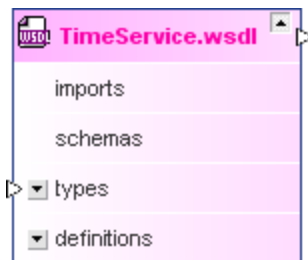

When you further expand the sub-sections, you can view details about the imported WSDL files or XML schema, the inline schemas, and the individual definitions of the web service.

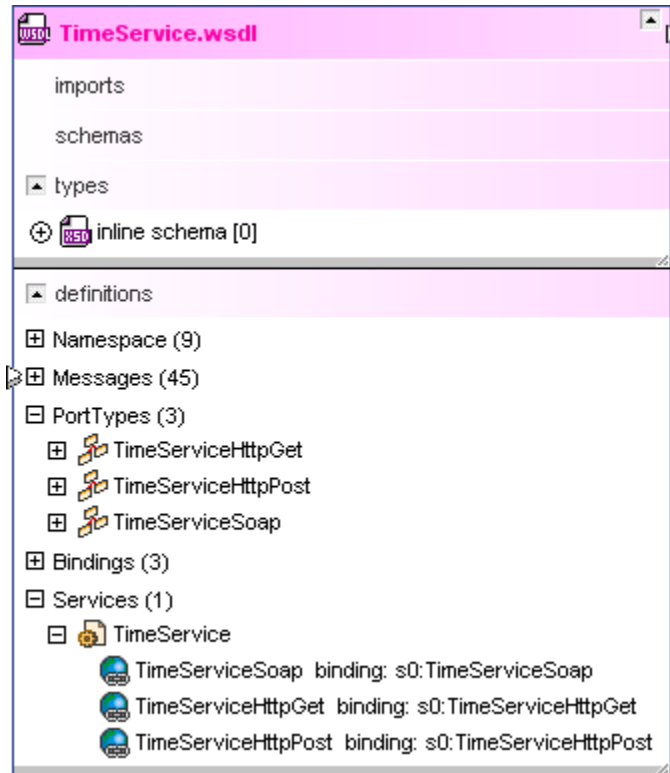

As of version 2010 Release 2, SchemaAgent also supports WDSL 2.0.

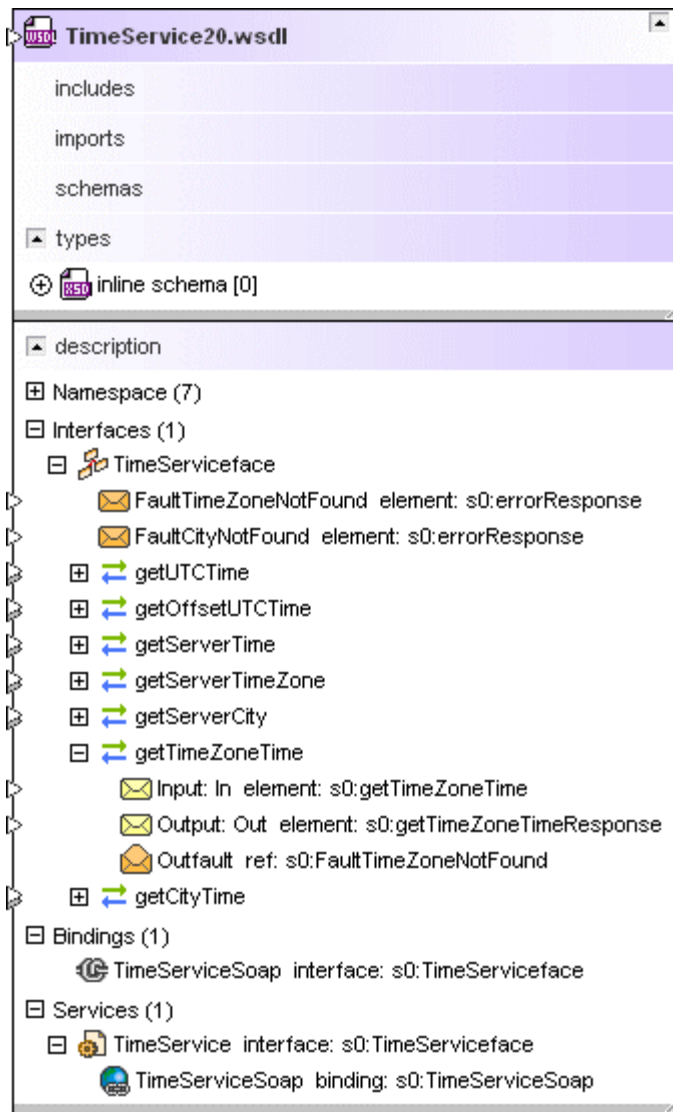

To view a WSDL file:

1. Drag-and-drop the WSDL file you want to view from the Explorer window onto a Design window or use the context menu to add the file to the current design.
2. Optionally, expand the sub-sections to view detailed information on imported WSDL or schema files, inline schemas, or web service definitions (WSDL 1.1) or web service descriptions (WSDL 2.0), respectively.

6.6.9 Displaying Relations

SchemaAgent can illustrate a number of different relations between the files it supports.

- IIR relations between [XML schemas](#) (includes, imports, and redefines)
- Relations between [XML instances](#) and XML schemas or XSLT stylesheets
- Include and import relations between [XSLT stylesheets](#) as well as relations between XSLT stylesheets and XML schemas
- Import relations between [WSDL files](#) as well as relations between WSDL files and XML schemas
- Relations between [MapForce Design \(MFD\) files](#) and XML schemas, XML instances, or WSDL files

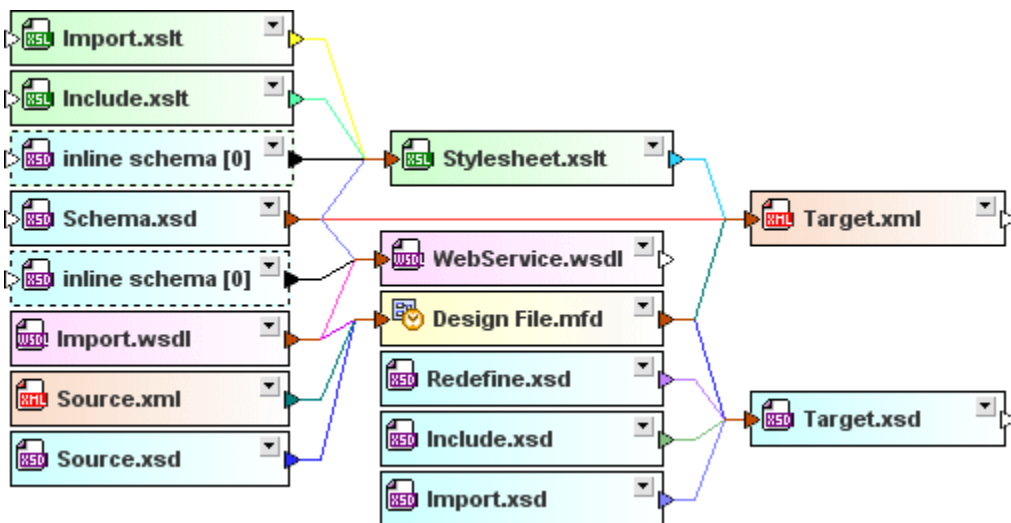

These relations are illustrated by solid lines between the individual file boxes by default. The lines have different colors indicating the kind of relations that exists between particular files. You can customize the appearance of the connector lines in the [Colors](#) and [Relations](#) tabs of the **Options** dialog (menu option **Tools | Options**).

Component relations

Lines to show relationships between global components in two schemas or between an MFD file and its source or target schemas, respectively, are dashed by default. If such lines connect two schema boxes, they lead from the respective component in the Globals section to the related component in the Globals section of the second schema.

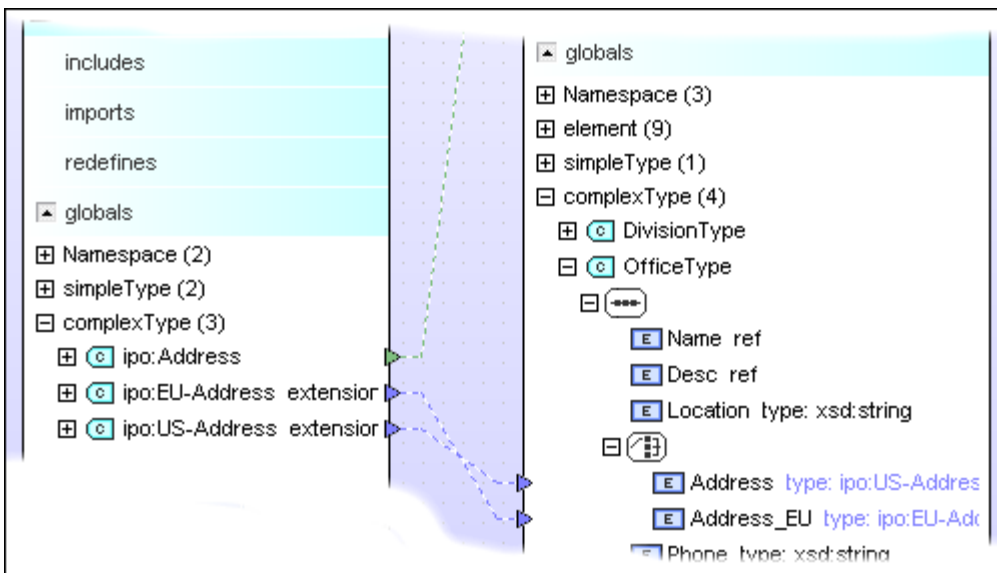

Please note: To display relationships between the components of two schemas, the Globals sections of both schemas must be expanded.

Component relations between an MFD file and its source and target schemas are indicated by dashed connector lines between the Globals section of the source schema box and the Input section of the MFD file, and the Output section of the MFD file and the corresponding Globals section of the target schema box, respectively.

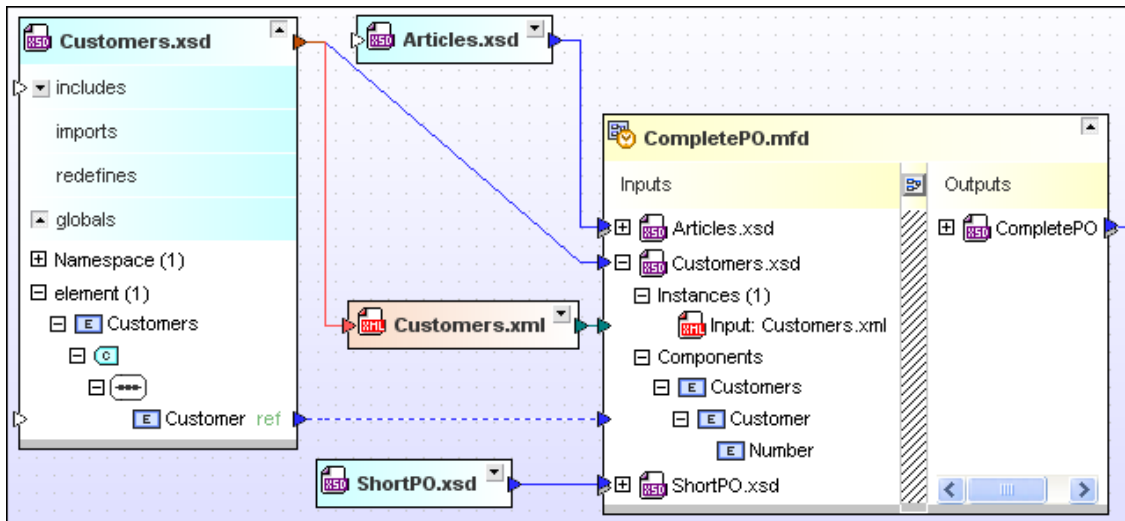

Please note: To display relationships between the components of an MFD file and its schemas, the Globals sections of the schema as well as the MFD file's Input or Output section, respectively, must be expanded.

Highlighting connector lines

When you place the cursor over a connector line, the line is highlighted. An arrowhead appears that indicates the "direction" of the relationship and a [Quick-Info box](#) with details of the relationship is displayed.

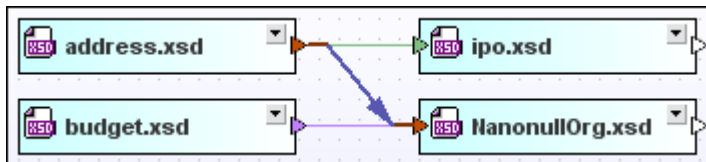

In the screenshot above, the blue import relation is highlighted and shows that `address.xsd` is imported in `NanoNullOrg.xsd`. The appearance of highlighted connector lines can also be configured in the Relations tab of the Options dialog.

Selecting connector lines

When you click a connector line, it is selected and several options are available in the context menu.

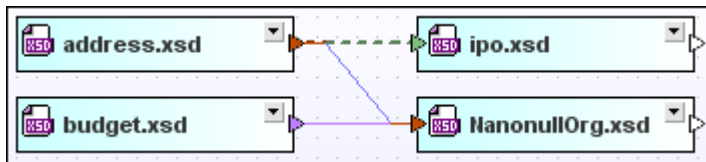

In the screenshot above, the green include relation is selected. The appearance of a selected line can also be configured the Relations tab of the Options dialog. Note that a selected line can also be highlighted (see screenshot below).

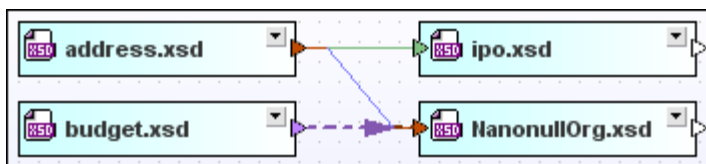

Schema Relationships

Lines to show relationships between schemas are solid by default and lead from the title bar of a schema box to the title bar of another schema box when the schema box is collapsed, or to an Include, Import, or Redefine section within a schema box when the schema box is expanded. Different colors are used to distinguish Imports, Includes, and Redefines; the default settings show Imports in light blue, Includes in green, Redefines in purple-violet.

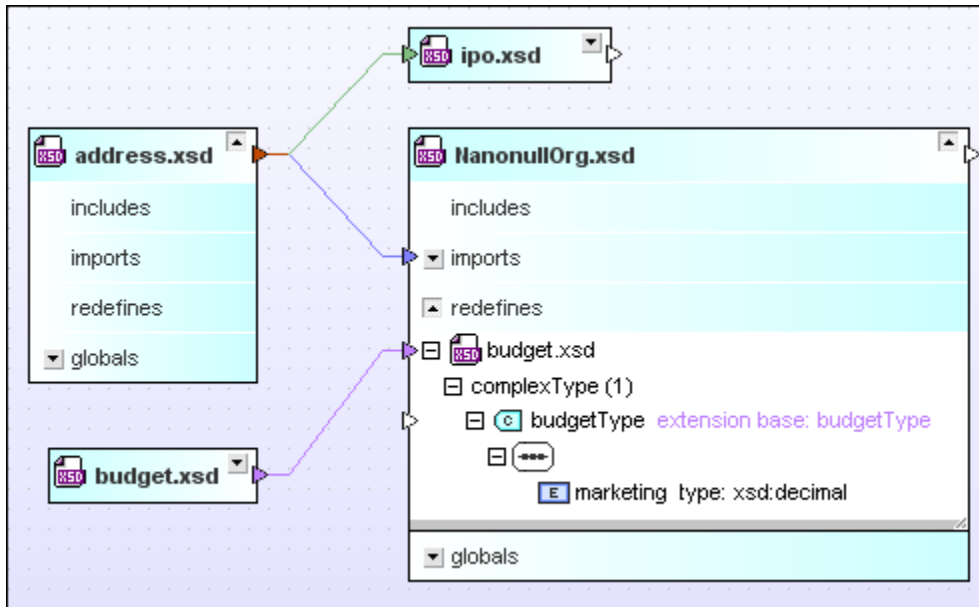

Note that the connector points directly to the referenced component if you also expand the section within the schema box.

XML Instances

Relationships that exist between XML schemas or XSLT stylesheets and their corresponding XML instances are also displayed in SchemaAgent.

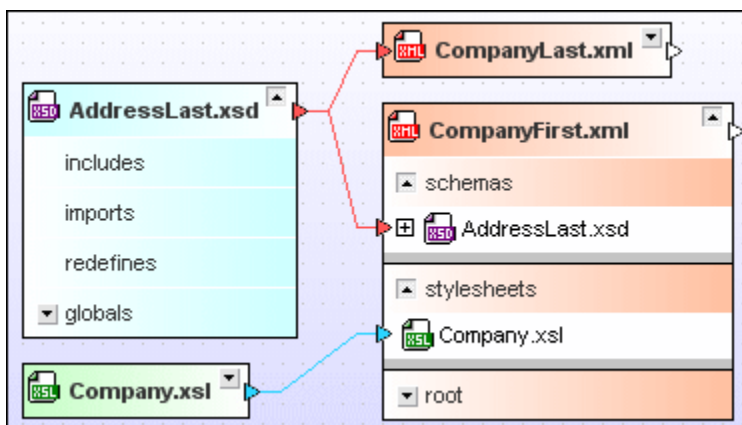

The connector lines lead from the title bar of an **XML schema** box to the title bar of an XML instance box when the XML box is collapsed, or to the schemas section within an XML box when the XML box is expanded. The default color for schema relations is red.

Relationships between **XSLT stylesheets** and XML instances lead from the title bar of a stylesheet box to the title bar of an XML instance box when the XML box is collapsed, or to the

stylesheets section within an XML box when the XML box is expanded. The default color for stylesheet relations is cyan.

Stylesheet Relationships

XSLT stylesheet files can import or include other XSLT files or XML schemas. In addition, one or several inline schemas may be present in an XSLT file. SchemaAgent illustrates these relationships with different colors.

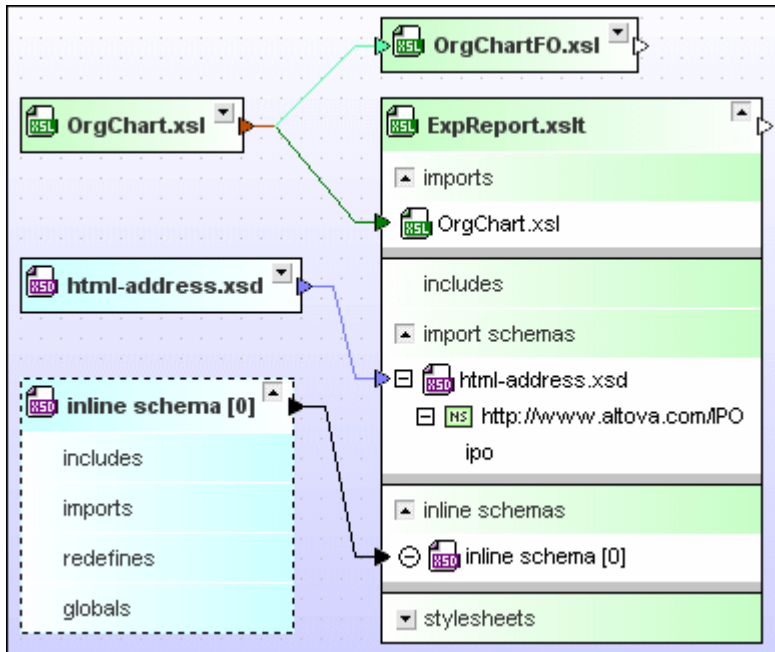

The connector lines lead from the title bar of an XML schema or XSLT stylesheet box to the title bar of an XSLT box when the XSLT box is collapsed, or to the imports, includes, or import schemas sections, respectively, within an XSLT box when the XSLT box is expanded. The default color for imports is dark green, for includes it is light green, and for schema relations it is light blue.

Changing the order

Since in XSL Transformations it is of importance in which sequence the imported or included stylesheets are applied, these files are not sorted alphabetically in the file boxes, but in the order of their insertion. You can, however, later on change this order using the sorting options in the context menu of the XSLT file box.

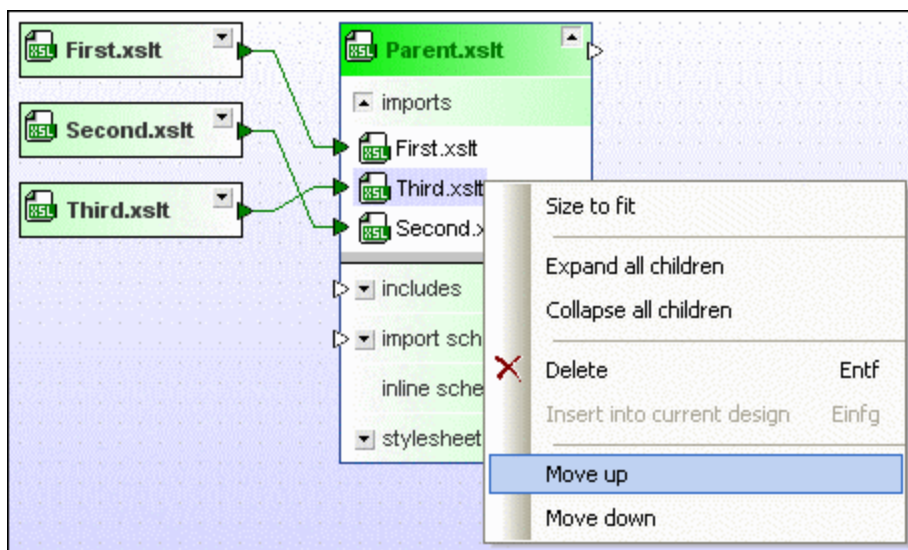

To change the order of imported or included XSLT files:

1. Expand the imports or includes section to view the related XSLT files.
2. Right-click the file whose position you want to change and choose one of the following options from the context menu:
 - Move up
 - Move down
3. Optionally, repeat step 2 until the file shows up at the desired position.

Inline schemas

Inline schemas are displayed when you expand the inline schemas section in an XSLT box. You can also show a file box for the inline schema. The file box for the inline schema has a dashed border, apart from that, you can proceed as with any other XML schema box.

To display a schema box for an inline schema:

1. Expand an XSLT box until the inline schemas are listed under the inline schemas section.
2. Right-click an inline schema and deactivate the **Show inline** option in the context menu or click the ☺ icon to the left of the schema name. Alternatively, you can also double-click the inline schema entry in the inline schemas section. The inline schema is displayed in a separate schema box which is connected to the inline schemas section of the XSLT file box.

To hide a schema box for an inline schema:

- Right-click an inline schema that has a schema box displayed in the WSDL box and activate the Show inline option in the context menu. Alternatively, click the ☹ icon to the left of the schema name, or double-click the inline schema entry in the inline schemas section.

WSDL Relationships

WSDL files can import other WSDL files or XML schemas. In addition, one or several inline schemas may be present in a WSDL file. SchemaAgent illustrates these relationships with different colors.

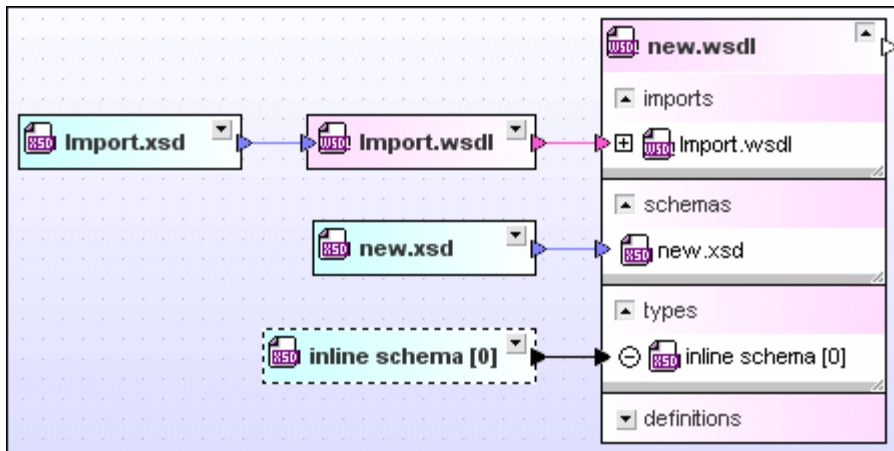

The connector lines lead from the title bar of an XML schema or WSDL box to the title bar of a WSDL box when the WSDL box is collapsed, or to the imports or schemas sections, respectively, within a WSDL box when the WSDL box is expanded. The default color for imports is magenta, for schema relations it is light blue.

Inline schemas are displayed when you expand the types section in a WSDL box. You can also show a file box for the inline schema. The file box for the inline schema has a dashed border, apart from that, you can proceed as with any other XML schema box.

To display a schema box for an inline schema:

1. Expand a WSDL box until the inline schemas are listed under the types section.
2. Right-click an inline schema and deactivate the **Show inline** option in the context menu or click the  icon to the left of the schema name. Alternatively, you can also double-click the inline schema entry in the types section. The inline schema is displayed in a separate schema box which is connected to the types section of the WSDL file box.

To hide a schema box for an inline schema:

- Right-click an inline schema that has a schema box displayed in the WSDL box and activate the Show inline option in the context menu. Alternatively, click the  icon to the left of the schema name, or double-click the inline schema entry in the types section.

MapForce Design Relationships

When an MFD file is concerned, solid connector lines lead from the input and output handles of the MFD file to the title bars of the respective source and target schema boxes or any existing XML instances, respectively. If the MFD file is expanded, the connector lines point to the schemas contained in the Input and Output section of the MFD file. You can further expand each schema to display XML instances contained in the Instances section.

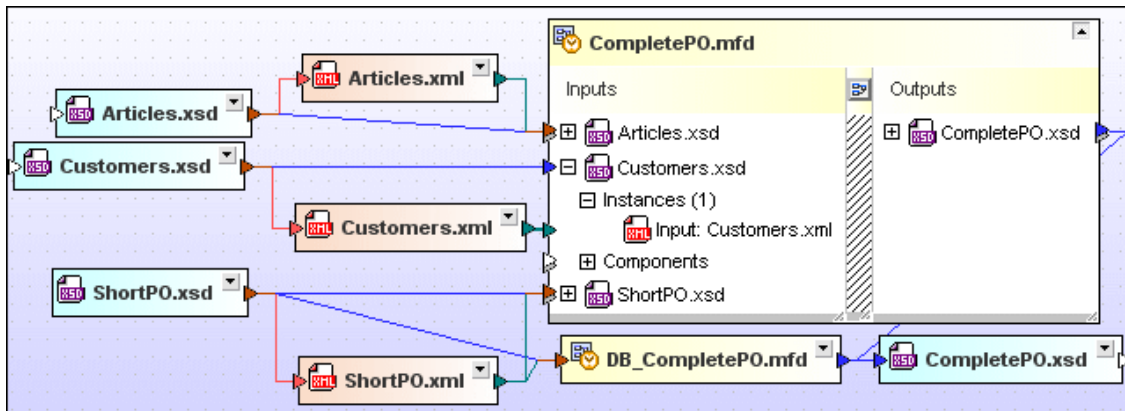

SchemaAgent uses different colors to indicate relations between MFD files and schemas (default color: blue) or XML instances (default color: green).

Relations between MFD files and WSDL files are illustrated with magenta connector lines between the title bar of an WSDL box to the title bar of a MFD box when the MFD box is collapsed, or to the Inputs and Outputs sections, respectively, within an MFD box when the MFD box is expanded.

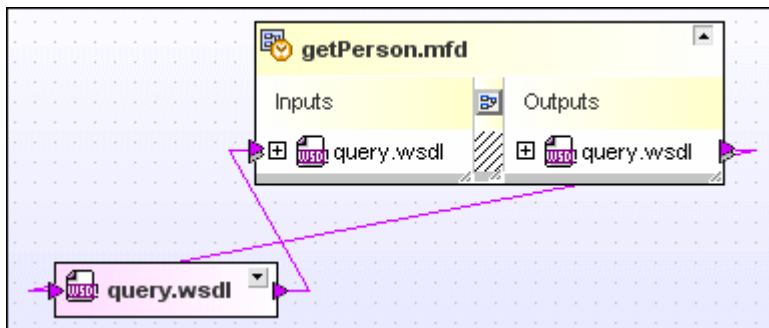

Toggleing the input and output instances

When you drag XML instances onto an XML schema inside an MFD box, normally the first XML instance is considered the input, and the second XML instance is considered the output. You can change that default allocation using the **Toggle instances** option in the context menu.

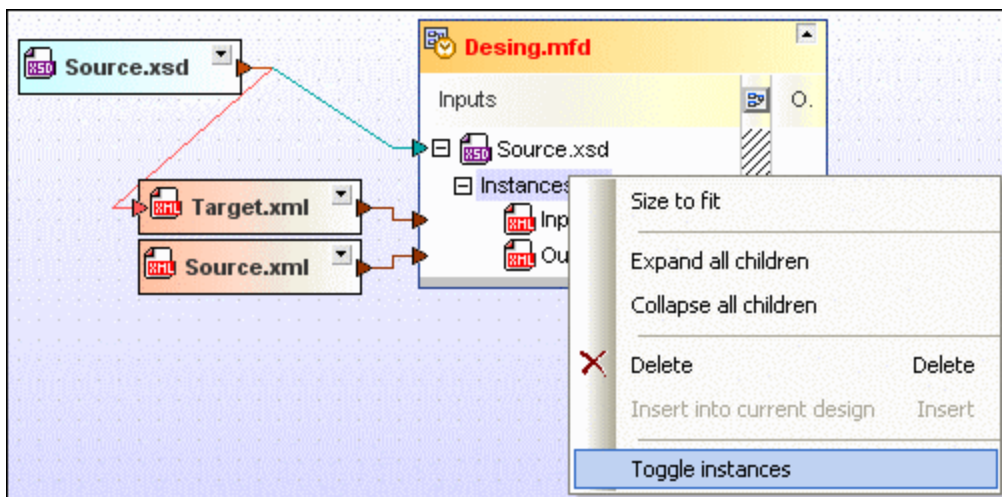

To toggle input and output instances:

1. Expand the MFD box to see the XML instances.
2. Right-click the parent XML schema, the Instances node, or either of the XML instances and choose Toggle instances from the context menu.

6.6.10 Showing Related Components

If a component or its type is defined in another schema (indicated by arrowheads on the left-hand-side of the component) or used by another schema (indicated by arrowheads on the right-hand-side of the component), the context menu that opens when you right-click that component provides the **Show component origin** (see *screenshot below*) as well as the **Show component usage** options. The text color of the complex type `ipo:US-Address` (blue) in the screenshot indicates that this complex type is an import (according to the default color scheme).

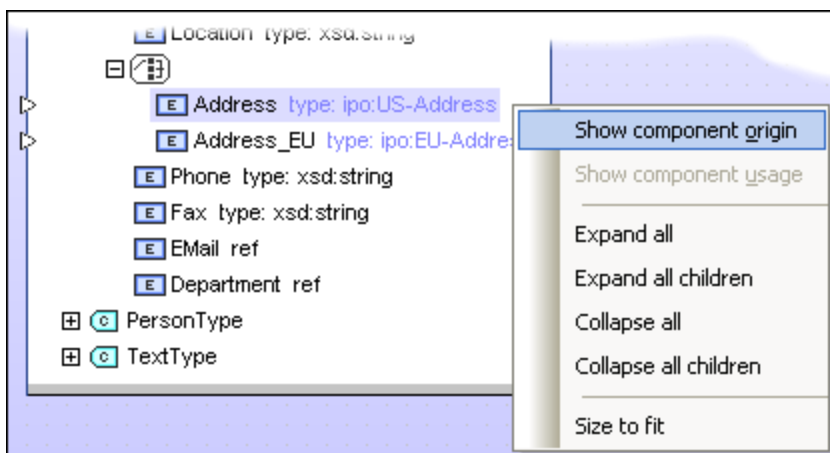

Selecting the **Show component origin** command from the context menu causes the connector line to the relevant definition in the source schema to be selected, together with the connector line showing the relation between both schemas (that is, whether it is an Include, Import, or Redefine). If the connector line is not visible because the relevant schema box or section, respectively, is collapsed, SchemaAgent will expand the design so as to be able to display the required connector lines. If the schema box containing the definition is not present in the design, a message to that effect is displayed and you are asked whether this schema box should be inserted into the design.

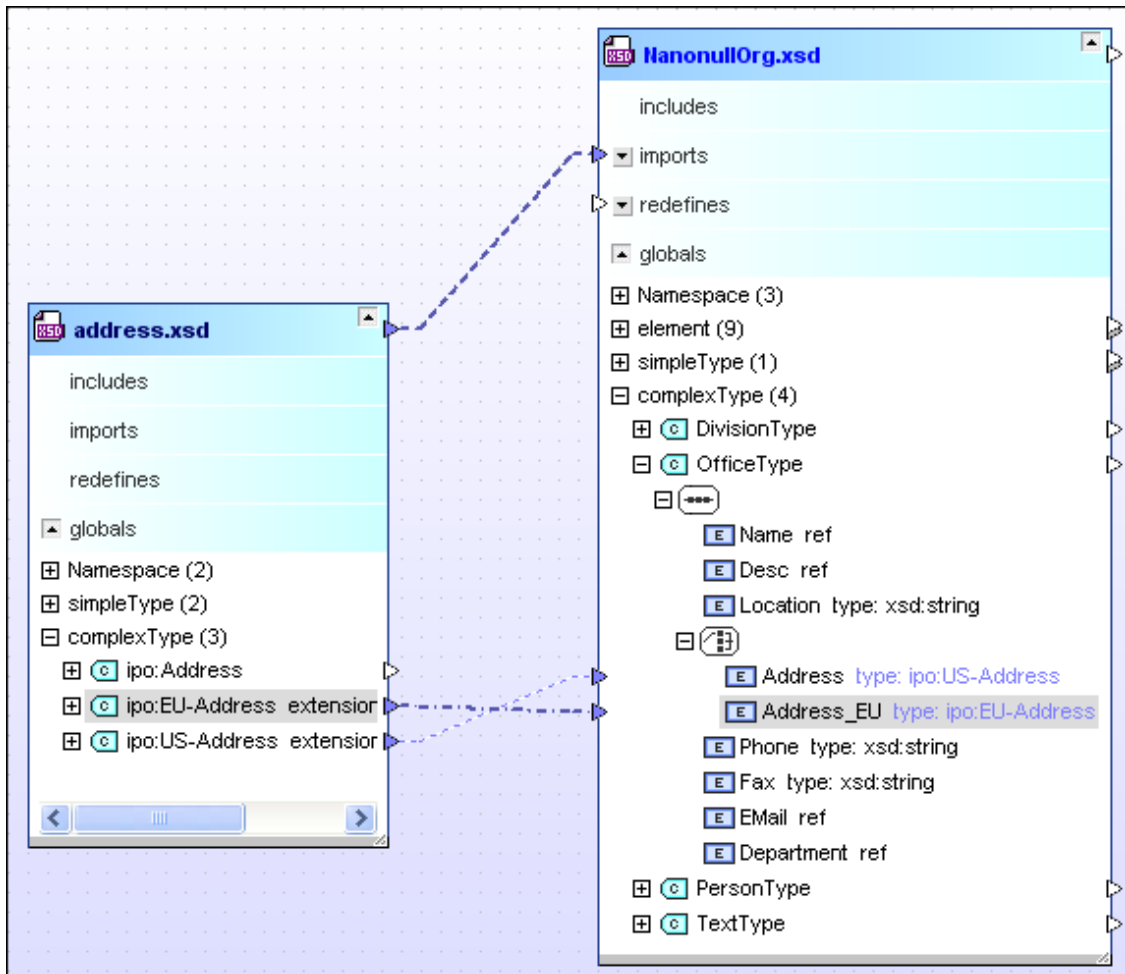

Conversely, if in the schema box of `address.xsd`, you right-click the component `ipo:Address` (a complex type), and select **Show component usage**, then the `ipo.xsd` schema box will be added to the design and the link to the `Address` element in `ipo.xsd` will be selected.

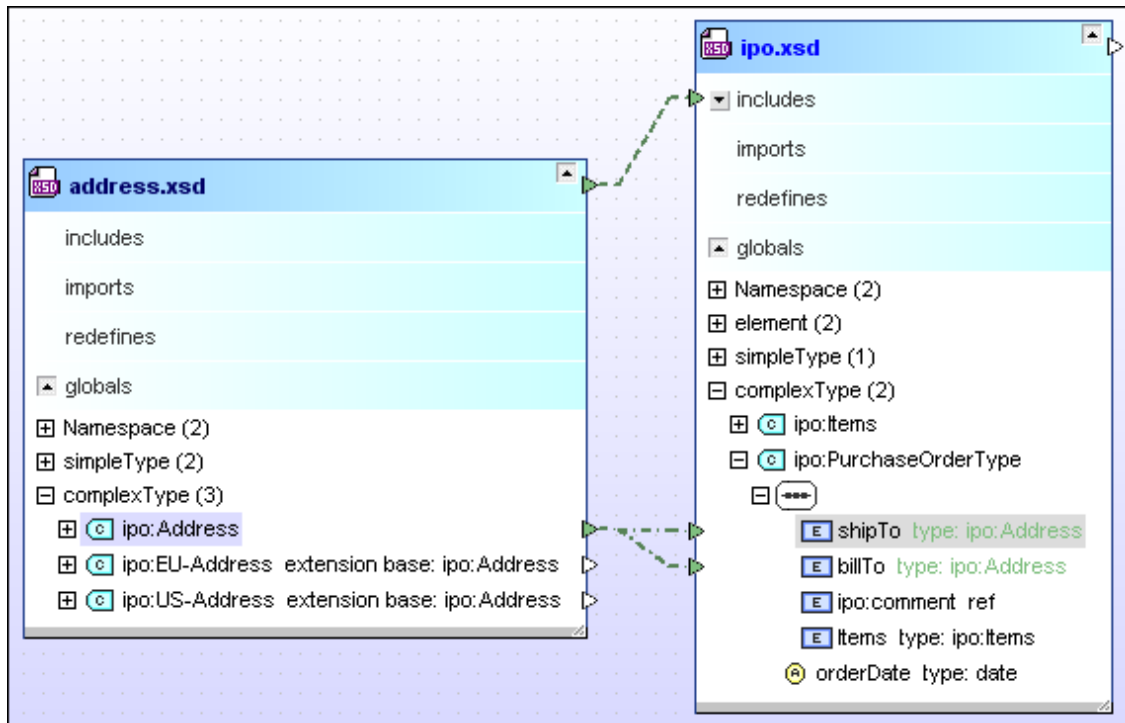

To show the origin of a component:

1. In the Globals section of a schema box, or in the Input or Output section of an MFD file box, respectively, right-click a component and select **Show component origin** from the context menu.
2. Optionally, click **Yes** in the message box that pops up if the schema of the source component is not present in the current design.

SchemaAgent will select the connector lines between the related components as well as the the connector line showing the type of relation between the schemas. If the schema box of the component source is collapsed, it will be expanded to the level required to display the relation.

To show the usage of a component:

1. In the Globals section of a schema box, right-click a component and select **Show component usage** from the context menu.
2. Optionally, click **Yes** in the message box that pops up if the schema of the target component is not present in the current design.

SchemaAgent will select the connector lines between the related components as well as the the connector line showing the type of relation between the schemas. If the schema box of the target component is collapsed, it will be expanded to the level required to display the relation.

6.6.11 Viewing MFD Files

When dragging one or several MFD files into the Design window, SchemaAgent displays the content of each individual MFD file as well as the mapping of the schemas contained in the MFD file.

Content

The content of an MFD file is indicated within the MFD file box. The input as well as the output files are listed when the box is expanded. Expand the MFD file box by clicking the expand 

button to the right of the file name to see which files are contained in the MFD file.

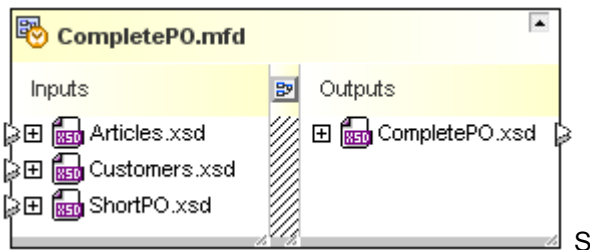

Click the expand buttons to the left of the input or output file names to drill down the structure of the individual files contained in the MFD file.

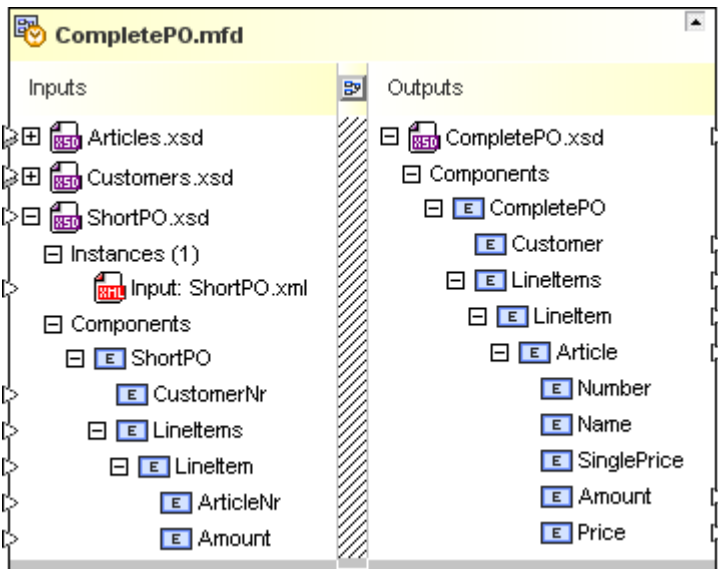

Mapping

The mapping of the input and output files contained in an MFD file can be viewed by clicking the **MapForce Design** icon located between the input and output files.

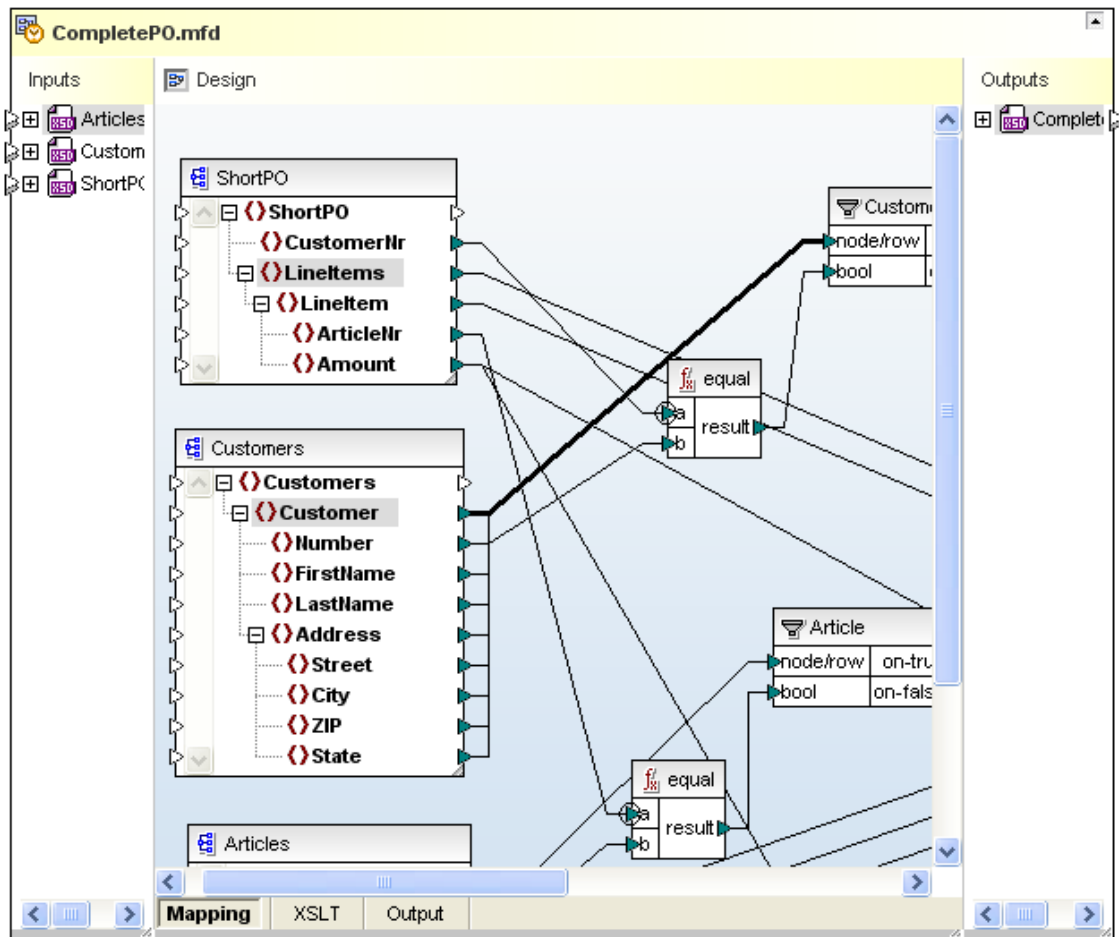

You can also view the XSLT file of the MapForce mapping and the XSLT output by clicking the respective tabs at the bottom of the MapForce Design pane. To close the pane, click the **MapForce Design** icon.

Please note: In order for the MapForce Design pane to be displayed, MapForce 2012 must be installed on your computer. You cannot edit an MFD file directly in SchemaAgent, you have to use the **Edit in MapForce** command from the context menu or press **Ctrl+M** to open the file in MapForce.

To view a MapForce design (MFD) file:

- Drag and drop the MFD file you want to view from the Explorer window onto a Design window.

6.6.12 Displaying Quick Information

When you mouseover the title bar of a file or highlight a connector line in a Design window, SchemaAgent displays a Quick-Info box with details on file location, target namespace, IIR information etc. The type and amount of information displayed in a Quick-Info box depends on the object being under the focus of the mouse pointer.

A Quick-Info box is provided for the following objects:

- Schema boxes
- Schemas contained in the individual sections of other schema boxes
- MFD file boxes
- Schemas contained in the Input or Output section of MFD file boxes

- XML instances
- IIR connector lines
- MapForce connector lines
- Component relation connectors
- References to XML instances

Schemas

When you mouseover the title bar of a schema box, a Quick-Info box containing the following information is displayed:

- Location of the schema
- Target namespace
- IIR information about the schema, for example, what schemas are included in that schema, and in which schemas that schema is included itself.

Please note: The Quick-Info box displays IIR information as determined in the search path.

Quickinfo XML Schema YNanonullOrg.xsd[

C:\...\Altova\XMLSpy2012\Examples\NanonullOrg.xsd

Target namespace:
<http://www.xmlspy.com/schemas/orgchart>
 Prefix: Ydefault namespace[

imports: (2 entries)
 address.xsd
 TextState.xsd

referenced by:
 NanoNullOrg.xml

Placing the text cursor over an **alert**  icon, if visible in the schema box, opens the relevant error message in the Quick-Info box.

When you have expanded a schema box and mouseover the file name of an included, imported, or redefined external schema, the Quick-Info box displays the following information on the external schema:

- Location of the schema
- Target namespace

MapForce design files

When you mouseover the title bar of a MFD file box, a Quick-Info box containing the following information is displayed:

- Location of the MFD file
- source file(s)
- target file

Quickinfo MapForce Design YCompletePO.mfd[
C:\...\Altova\MapForce2012\MapForceExamples\CompletePO.mfd

reading from: (3 entries)
ShortPO.xsd
Articles.xsd
Customers.xsd

writing to:
CompletePO.xsd

When you mouseover the file name of a schema contained in the MFD file, the Quick-Info box displays the following information:

- Location of the schema
- Target namespace

XML instances

When you mouseover the title bar of an XML instance file box, a Quick-Info box containing the following information is displayed:

- Location of the XML file
- referenced file(s)
- files writing the XML instance
- files reading the XML instance

Quickinfo XML Instance Yinput.xml[
C:\...\Altova\MapForce2012\MapForceExamples\Tutorial\input.xml

references:
Input.xsd

written by:
Summing-nodes.mfd

read by:
Summing-nodes.mfd

XSLT stylesheets

When you mouseover the title bar of an XSLT stylesheet box, a Quick-Info box containing the following information is displayed:

- Location of the XSLT file
- XSL Version
- imported XSLT files
- included XSLT files
- imported XML schemas
- Files containing the XSLT file
- inline schemas contained in the XSLT file

Quickinfo XSL YExpReport.xslt[

C:\...\Altova\XMLSpy2012\Examples\ExpReport.xslt
version Z 2.0

imports:
 OrgChart.xsl

includes:
 OrgChartFO.xsl

imports:
 html-address.xsd

imported in:
 Master.xslt

contains:
 inline schema x0z

Web Service Description files

When you mouseover the title bar of a WSDL file box, a Quick-Info box containing the following information is displayed:

- Location of the WSDL file
- WSDL version
- Target namespace
- imported WSDL files
- imported XML schemas
- files containing the WSDL file
- files reading the WSDL file
- inline schemas contained in the WSDL file

Quickinfo WDSL YWebService.wsdl[

C:\...\Altova\MapForce2012\UPSRates.wsdl

version Z 1.1

Target namespace <http://www.mackeybros.com/WebServices/>
Prefix: tns

is written by:
 Complete POws.mfd

is read by:
 Complete POws.mfd

contains:
 inline schema x0z

Relations

When connector lines between schemas, MFD files, XML instances, or components and their respective source or target item are highlighted, a Quick-Info box is displayed. The content of the Quick-Info box differs depending on the type of the highlighted connector.

The following is displayed for relations:

- Type (Import, Include, Redefine, MapForce, or Reference)
- Source

- Target

Quickinfo YRelation[

Type: MapForce
Source:
Customers.xsd
Target:
CompletePO.mfd

When you mouseover a component relation, the Quick-Info box contains information regarding the input component the MapForce item reads from, or the MapForce item the output component is written by, respectively.

Quickinfo YComponent Relation[

MapForce: ArticleNr (CompletePO.mfd) reads from ArticleNr (ShortPO.xsd)

Quickinfo YComponent Relation[

MapForce: Customer (CompletePO.xsd) is written by Customer (CompletePO.mfd)

The Quick-Info box for a component nested in a schema box looks similar.

Quickinfo YComponent Relation[

Import: Address (NanonullOrg.xsd) uses ipo: US-Address (address.xsd)

6.7 Working with Designs

When working with SchemaAgent designs in a Design window, you can not only [select](#) file boxes, rearrange or [remove](#) them, but also [reload files](#) that have been changed outside SchemaAgent Client as well as [print](#) and [export](#) designs. Context menus are available for the [design](#) itself as well as for file boxes and [connector lines](#). You can [correct incorrect reference paths](#) and even [recreate ghost files](#).

6.7.1 Selecting Files

When selecting a single file in a Design window, the file box changes its color and the selected box will automatically receive the focus, which is indicated by the title also being displayed in a different color (see *screenshot*). You can change the color for selected files in the [Options](#). In the description below, the selection mechanism is explained with reference to schemas; note that the same mechanism also applies to MFD files as well as XML, WSDL, and XSL files.

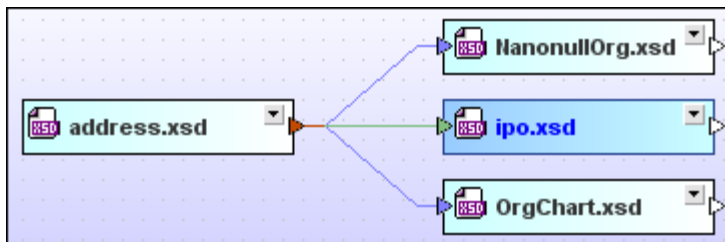

To select a schema in a Design window:

- Click anywhere inside the schema box.

Selecting multiple files

In a Design window, several schemas, MFD, or XML files can be selected at a time. The title bars of the selected files will change their color. The way in which you select the files, determines which file will get the focus:

- If you use the **Ctrl+click** method to select multiple file boxes, the last file box that is selected will receive the focus.
- If you use the marquee selection method, the last file box over which the cursor passes will receive the focus.
- If you drag the marquee in such a way that the cursor passes over no file box, then no file will receive the focus.

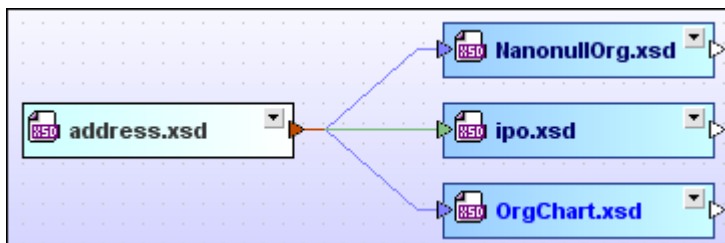

To select multiple schemas in a Design window:

Do one of the following:

- Click the schema boxes of the schemas you wish to select while keeping the **Ctrl** key pressed.
- Use the marquee selection technique on the schema boxes of the schemas you wish to

select (that is, click and drag the marquee rectangle around the required schema boxes).

Changing the focus

For some actions, such as aligning, it is important to set the focus correctly because the selected files are aligned on the file that has the focus. For other actions, such as sorting, the focus is irrelevant.

To change the focus in a multiple selection:

- Press **Ctrl** and click twice on the box of the file to which you want to give the focus.

Selecting related files

Schema boxes are also selected when the [Show Component Origin](#), [Show Component Usage](#), and [Show Relation Path](#) commands are used.

Another way to select related files in a design is to right-click a file and choose one of the following options from the **Select** sub-menu of the context menu. Each of the options provides a sub-menu where you can further restrict your choice to certain file types, or choose **Files** to select all files.

- **All directly referenced**: Selects all files that are directly referenced by the selected file.
- **All directly referencing**: Selects all files that are directly referencing the selected file.
- **All directly related**: Selects all files that are either directly referenced by, or are directly referencing the selected file.
- **All referenced**: Selects all files that are directly as well as indirectly referenced by the selected file.
- **All referencing**: Selects all files that are directly as well as indirectly referencing the selected file.
- **All related**: Selects all files that are either referenced by, or are referencing the selected file directly as well as indirectly.
- **All linked**: Selects all files that are directly and indirectly referenced, as well as files that are linked to any of the directly or indirectly referenced files in any way.

Alternatively, you may also select a file in the Design window and choose the menu option **Edit | Select**. Use one of the options in the appropriate sub-menu to select the desired files in the Design window.

In addition to the menu, you can always use the keyboard shortcut **Ctrl+A** to select all files in the active Design window.

Copying and pasting a selection

Selections can be copied and pasted across designs. When used with paths, this is a convenient way to create new designs containing closely related schemas.

Synchronizing Selections

The context menu of a selected file box provides an option to synchronize the selection in the Design window and the Explorer window. This command is most useful when a Design window is active because it is not possible to rename, delete, or move a file in a Design window. So, if you choose the **Synchronize Selection** command in the Design window, then the currently selected file in the Design window is also selected in the Hierarchical and Flat tabs of the Explorer window, enabling you to switch to the Explorer pane and take the required action.

Please note: Synchronized selection only applies to the currently selected Design window and not to all open Design windows.

To synchronize a selection:

Do one of the following:

- Double-click a file in the Hierarchical tab or the Flat tab of the Explorer window, or in a Design window.
The file is then selected in the other two tabs as well.
- Choose the menu option **Edit | Synchronize Selection**.
- In a Design window, right-click a file box and choose **Synchronize Selection** from the context menu.
- Click the **Synchronize Selection**  button in the standard toolbar.

6.7.2 Removing Files

In contrast to [deleting a file in the Explorer](#) window, a file that is removed from a design will remain available in the file system of your computer as well as in other designs where it is contained.

Please note: Be sure that the focus of the selected file is on the Design window and **not** in the Explorer window if you just want to remove the file from the design. Otherwise you will delete the file from your file system and it will not be removed from the design but will appear as a so-called **unknown file** since the relevant SchemaAgent server is not able to locate a file of the given name in any of its search paths. Such a file is represented in Design windows with a yellow exclamation mark.



The only way to bring a deleted file back into use (thus making the yellow exclamation mark disappear) is to have the file physically re-created or copied from a backup to its correct location.



To remove a file from a design:

Do one of the following:

- Right-click a file in a Design window and select **Delete** from the context menu.
- Select a file in a Design window and choose the menu option **Edit | Delete** or press the **Delete** key.
- Click the **Delete**  button in the Standard toolbar.

The file is removed from the design.

6.7.3 Ghost Schemas and Incorrect Paths

If a file contains a reference to another file that cannot be found at the specified location—a so-called ghost file—an error  icon appears in the top left of its title bar. The ghost file is indicated by the ghost  icon in its title bar. In the screenshot below, `ipo.xsd` has an Include statement that points to the schema `address.xsd`, which cannot be located at the location specified in the Include statement. In this case, `address.xsd` is the ghost schema file. All files that reference `address.xsd` in an IIR statement are marked with the error  icon, both in their schema boxes as well as in the Explorer pane (see *screenshot*).

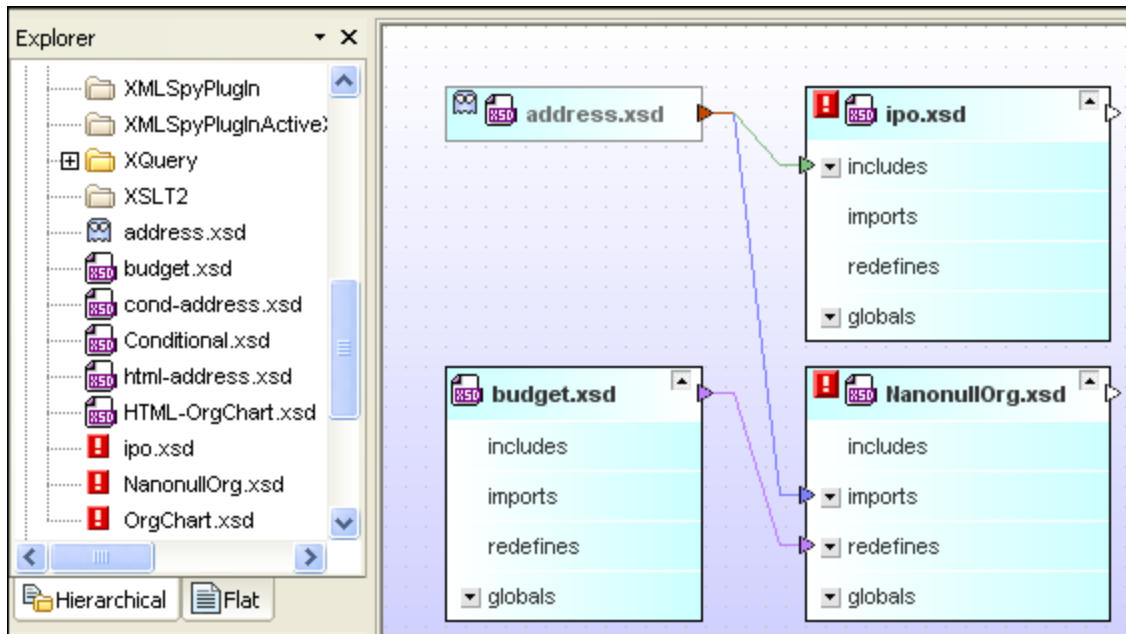

An XML instance is also marked and treated as ghost file if it cannot be found at the location specified in the MFD file(s) by which it is written.

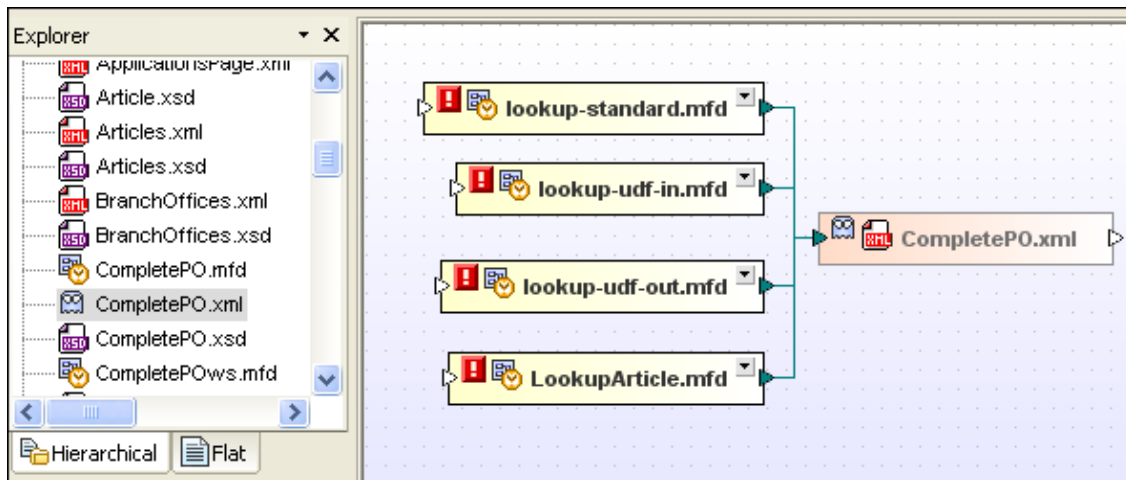

A schema can be a ghost schema for any of several reasons. The most common are:

- The schema is not physically present at the specified location for any of several reasons. For example, it might have been moved.
- The schema cannot be loaded because the web server or network node is unavailable.

Note that ghost files are displayed in the Explorer and Design windows (even though they are not at the location specified in the reference). In the design, the connector line between the ghost file and its target schema is also displayed.

If you encounter incorrect references and ghost files, there are two possible ways to deal with the problem:

- [Correcting the path to the reference](#)
- [Recreating the ghost file](#)

Correcting Reference Paths

SchemaAgent Client offers the **Correct reference paths** command when you right-click the file with the incorrect reference. This action causes SchemaAgent Client to look for files of the same name in the search path. This is the ideal solution if the ghost file has been moved to another location within the search path. In such cases, SchemaAgent Client lists all the files with the ghost file's name that it finds in the search paths. You can then select the correct path, and this path will be inserted as the reference.

When a reference in a file (that is, either an IIR statement in a schema or a schema specification in an MFD file) points to a file that cannot be found at the location specified, you can use the **Correct reference paths** command to make SchemaAgent look for a file with a name matching that of the referenced file at other locations in the search path. If one or more matches are found, a dialog box appears displaying the available alternative paths.

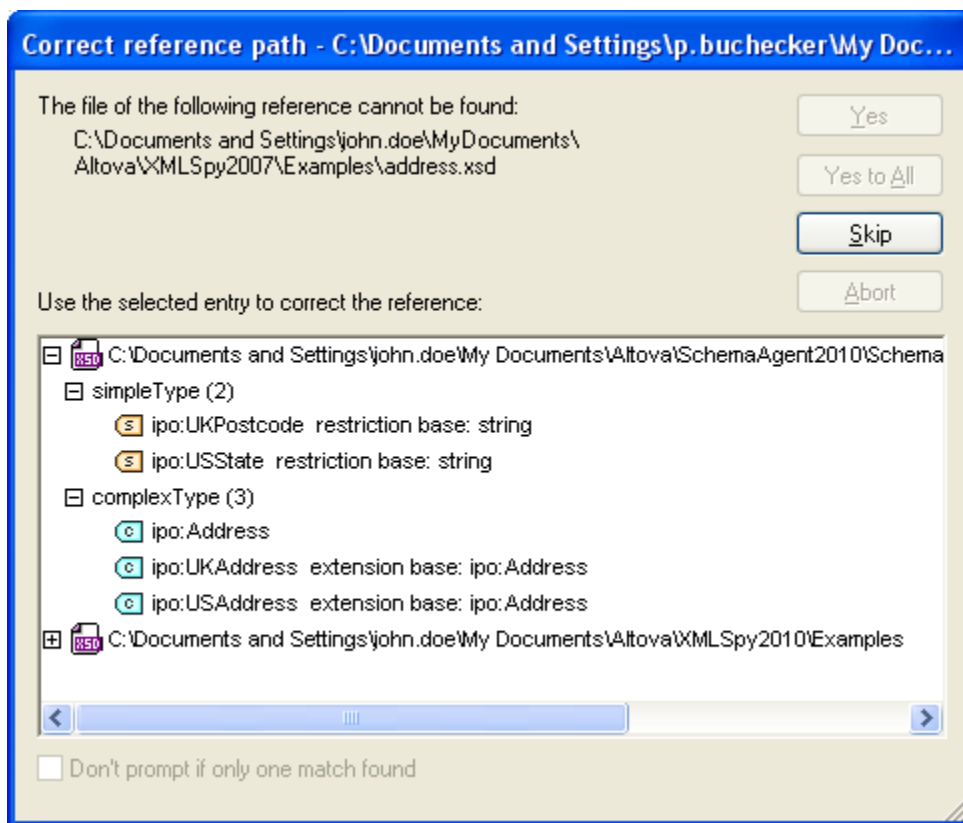

In the **Correct reference path** dialog box, you can expand the individual hits to check if the structure of the found file is really identical with the missing file. The dialog box is resizable so that you can display even very long paths or show complex schemas in detail without having to use the scroll bars.

You can also attempt to correct all incorrect paths in one single step. In this case, SchemaAgent displays a dialog box, where you can choose to correct the path without prompt if only one match is found.

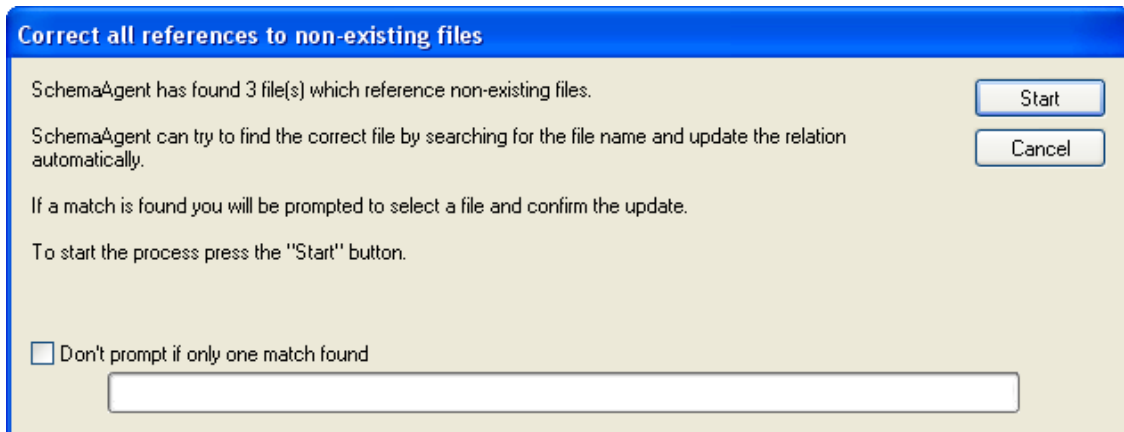

Please note: The menu option **Extras | Correct all reference paths** will correct all paths in SchemaAgent independent of the files displayed in a design window. You can also perform this operation with no Design window open.

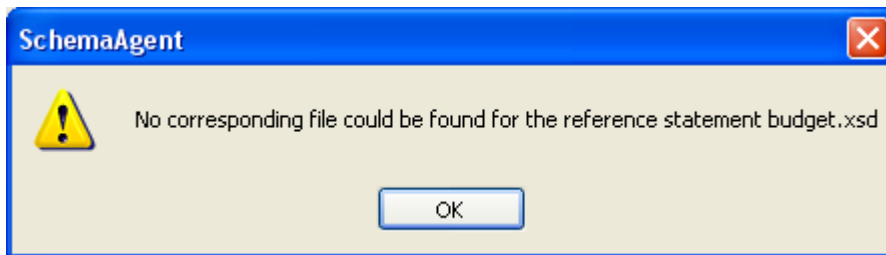

When you have started the process, a separate **Correct reference path** dialog box is displayed for each of the ghost files that are present in the design. If no match is found for a particular ghost file, this is reported in a message box.



To correct a single reference path:

- In the Explorer window or in a Design window, right-click a file with an error  icon and select **Correct reference paths** from the context menu, or select the file and press **Ctrl+R**, or click the **Correct reference paths**  button in the Extras toolbar.

To correct all reference paths:

1. Select the menu option **Extras | Correct all reference paths**.
The **Correct all references to non-existing files** dialog box opens.
2. Optionally, activate the **Don't prompt if only one match found** check box if you want paths corrected automatically when only one alternative path is found.
3. Click **Start**.
The **Correct reference path** dialog box appears for the first ghost file. Do one of the following:
 - Select a matching path and click **Yes** to confirm the correction (a single match will be confirmed automatically without showing the **Correct reference path** dialog box if the **Don't prompt if only one match found** check box has been activated).
 - Click **Yes to All** to confirm all single matches without prompting.
 - Click **Skip** to jump to the next ghost file without correcting the current path.
 - Click **Abort** to terminate the process without correcting the remaining paths.

Recreating Ghost Files and XML Instances

From within SchemaAgent Client, you can recreate the ghost schema as a rudimentary schema at the location specified in the reference. A rudimentary schema is one that contains only the `xs:schema` declaration. A ghost XML instance is recreated as a rudimentary XML file containing only an empty `<root />` element.

Note that if the folder specified at the location defined in the reference statement does not exist or is not within the search path, then the **Recreate** command is not available. This solution ensures that the IIR or reference path correctly points to the specified schema or XML file, respectively. However, you still have to add appropriate content to the recreated rudimentary file.

To recreate a schema:

1. In the Explorer window or in a Design window, select a ghost schema and do one of the following:
 - Choose the menu option **Edit | Recreate**.
 - Right-click and select **Recreate** from the context menu.A rudimentary schema of the same name is created at the location specified for it in the IIR statement.
2. Open the rudimentary schema in XMLSpy and add appropriate content.

To recreate an XML file:

1. In the Explorer window, right-click a ghost XML file and select **Recreate** from the context menu.
A rudimentary XML file of the same name is created at the location specified for it in the reference.
2. Open the rudimentary XML file in XMLSpy and add appropriate content.

6.7.4 Reloading Files

If a file is edited in an external editor program (for example, XMLSpy or MapForce), the changes are not automatically reflected in SchemaAgent Client. In order to view the structure of the modified file in SchemaAgent Client, you have to reload the respective file.

To reload a file:

- Right-click the required folder or file in the Explorer window or in a Design window and select **Reload** from the context menu.

6.7.5 Design Options

The context menu that opens when you right-click anywhere in a Design window pane provides a series of commands that facilitate the editing and layouting of a SchemaAgent design. The content of the menu changes dynamically depending on where you right-click in the Design window:

- Design window background
- File box or section caption (the content also changes depending on the file type)
- Blank area in a section
- Item in a section (the content also changes depending on the item type)

Design window background

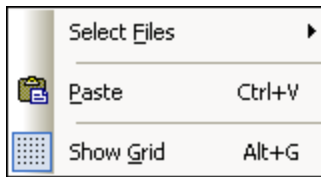

- **Select Files:** Opens a sub-menu for selecting file boxes by type.

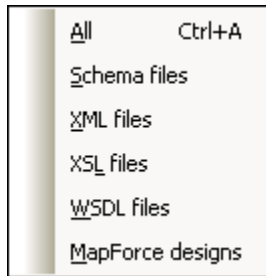

- **Paste (Ctrl+V):** Pastes a file box that you have previously copied into the clipboard from the Explorer.
- **Show Grid (Alt+G):** Toggles the display of the [grid on and off](#).

File box or section caption

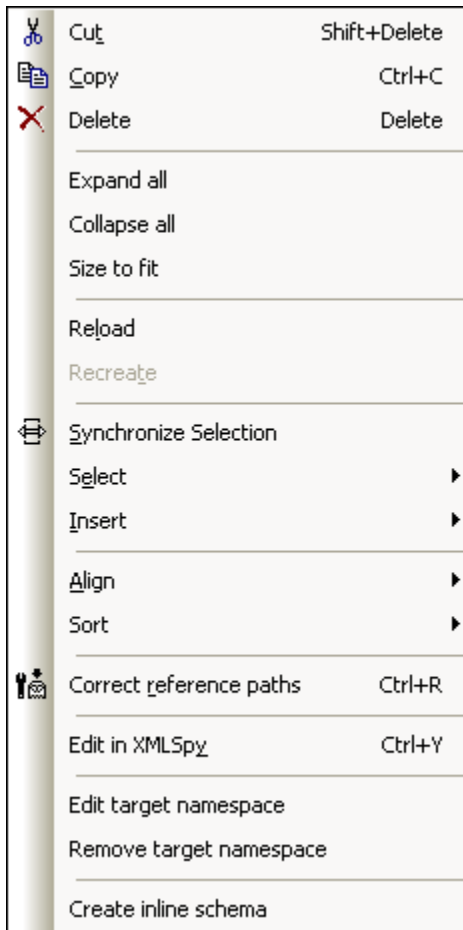

- **Cut (Shift+Delete):** Copies the selected file(s) to the clipboard and deletes it from the design.
- **Copy (Ctrl+C):** Copies the selected file(s) to the clipboard. You can use this command to copy files from one design window to another.
- **Paste (Ctrl+V):** Pastes the content of the clipboard to the active design window.
- **Delete:** [Removes the selected file\(s\)](#) from the design. Please note that the files will not be deleted from the file system.
- **Expand all:** Expands all sub-sections (includes, imports, redefines, globals, Inputs/Outputs, schemas, stylesheets, root, import schemas, inline schemas, stylesheets, types, definitions) of the selected file box.
- **Collapse all:** Collapses all expanded sub-sections of the selected file box.
- **Size to fit:** Resizes the file box so that all expanded content is visible.
- **Reload:** [Updates the display](#) of the selected files. If more than one file is selected, the command reads **Reload files**.
- **Recreate:** [Creates a rudimentary XML schema](#) with the name of, and at the location specified in an IIR statement for, the selected ghost schema(s). This option is only available for [ghost files](#). If more than one file is selected, the command reads **Recreate files**.
- **Synchronize Selection:** [Synchronizes the selection](#) of the Explorer and the Design windows, so that the file selected in the Design window is also selected in the Explorer.
- **Select:** Opens a sub-menu providing several [selection](#) options.

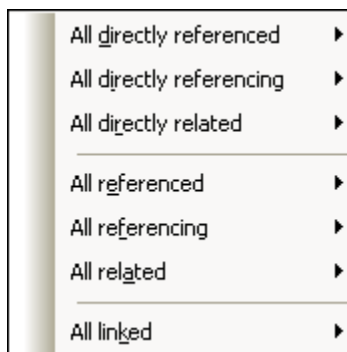

- **Insert:** Opens a sub-menu (identical to the **Select** sub-menu illustrated above) providing several options for [inserting related files](#).
- **Align:** Opens a sub-menu providing several options for [aligning the selected files](#) and toggles the grid display on and off.

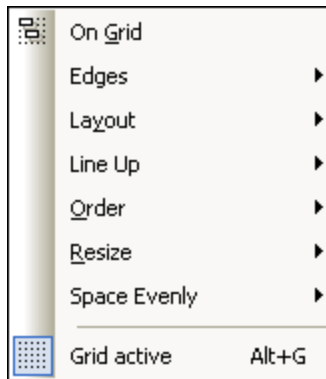

- **Sort:** Opens a sub-menu where you can [sort the selected files](#) by name or by width, either ascending or descending.



- **Correct reference paths (Ctrl+R):** Tries to [find an identical file](#) at a different location within the defined search paths. This option is only available for files with an IIR statement defined pointing to a file that cannot be found at the specified location.
- **Edit in XMLSpy:** Opens the selected files for editing in XMLSpy. This option is not available for MFD files. If more than one file is selected, the command reads **Edit files in XMLSpy**.
- **Edit files in MapForce:** Opens the selected files for editing in MapForce. This option is only available for MFD files. If more than one file is selected, the command reads **Edit files in MapForce**.
- **Edit target namespace:** Allows you to add an additional namespace to the namespace definition in the Globals section of the selected schema. SchemaAgent expands the Globals section of the schema box and adds a new `ns` element where you can enter the definition of the target namespace. If a target namespace is already existing, it is selected for editing.
Please note: In WSDL files that contain inline schemas, the target namespaces also applies to the inline schemas. You may have to consider this if you plan to edit or delete the target namespace in a WSDL file.
- **Remove target namespace:** Deletes the target namespace from the selected schema.
- **Create inline schema:** Creates an inline schema for the selected XSLT or WSDL file. This option is not available for schemas, MFD files, and XML instances.

Blank area in a section

If you right-click into a blank area of an expanded section, the context menu provides the **Size to fit**, **Expand all**, and **Collapse all** commands. The definitions section of a WSDL file box additionally offers the **Edit target namespace** and **Remove target namespace** commands. Please note that these commands apply only to the particular section where the cursor is positioned when calling the command.

Items in a section

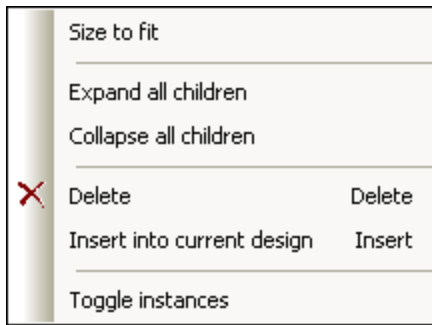

- **Size to fit:** Resizes the section so that all expanded items are visible.
- **Expand all children:** Expands any available children of the selected item.
- **Collapse all children:** Collapses any available expanded children of the selected item.
- **Show inline:** In XSLT and WDSL file boxes, shows the inline schema as a separate schema box.
- **Delete (Delete):** Deletes the IIR relation between the item and the parent file (i.e., the file that is represented by the file box in which the item is displayed).
- **Insert into current design (Insert):** Inserts the corresponding file box of the item into the current design. This option is grayed out if the file box is already present in the design.
- **Toggle instances:** In MFD file boxes, toggles between input and output XML instances. You can use this option independently for the input and output schemas of the MFD file. This option is only available for MFD files.
- **Show component origin:** Selects and expands the file box where the component originates from or inserts that file box into the design, if desired.
- **Show component usage:** Selects and expands the file box where the component is used or inserts that file box into the design, if desired.

Drag-and-drop

In addition to the options available in the context menu, you can also use drag-and-drop to move a file within a design window or to copy a file to another design window.

To move a file within a Design window:

- Drag the file to the desired position.

To copy a file to another Design window:

- Drag the file from the first Design window to the desired Design window and drop it. If the target window is not visible, move the mouse pointer to the corresponding tab at the bottom of the Design window to activate the target window and drop the file there.

Aligning Files in Designs

SchemaAgent provides several options for automatically aligning the file boxes in a Design window. You can select these options either via the **Layout** menu, by selecting and right-clicking several file boxes in a Design window, or by clicking the appropriate toolbar icon in the Alignment toolbar.

Aligning box edges

When several file boxes are selected in a Design window, you can choose from among several

aligning options provided in the sub-menu that opens when you select the menu option **Layout | Align Edges** or when you right-click the Design pane and select **Align | Edges** from the context menu.

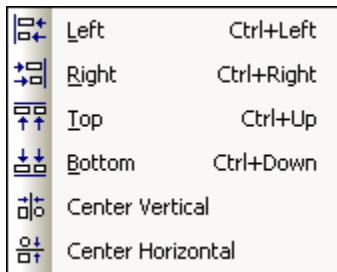

The selected file boxes will be aligned with the file box that has the focus. You can change the focus within a selection by double-clicking a file box while holding down the **Ctrl** key. If you add a file to a selection, the focus will be automatically set to the newly added file.

To align the edges of file boxes:

1. Select the file boxes you want to align, giving the focus to the file box you want to align the others with.
2. Select the menu option **Layout | Align Edges** or right-click and select **Align | Edges** from the context menu. A sub-menu appears.
3. Select from this sub-menu, how you want the edges aligned. Alternatively, skip step 2 and do one of the following:
 - Press **Ctrl+Left** or choose the **Align Left Edges** icon from the Alignment toolbar.
 - Press **Ctrl+Right** or choose the **Align Right Edges** icon from the Alignment toolbar.
 - Press **Ctrl+Up** or choose the **Align Top Edges** icon from the Alignment toolbar.
 - Press **Ctrl+Down** or choose the **Align Bottom Edges** icon from the Alignment toolbar.
 - Choose the **Align Vertical Center** icon from the Alignment toolbar.
 - Choose the **Align Horizontal Center** icon from the Alignment toolbar.

Layouting the design

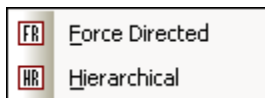

In SchemaAgent, you can have the layout of a Design window drawn automatically. Two options are available in the **Layout** sub-menu to this aim when more than one file box is selected.



To automatically layout a design:

1. Select at least two file boxes in a Design window.
2. Select the menu option **Layout | Layout** or right-click and select **Align | Layout** from

the context menu.
A sub-menu appears.



3. Select the appropriate layout from the sub-menu.
Alternatively, skip step 2 and do one of the following:
 - Choose the **Layout using force-directed algorithm**  icon from the Alignment toolbar.
 - Choose the **Layout as a hierarchy**  icon from the Alignment toolbar.

Lining up file boxes

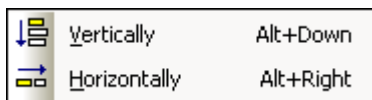
Using the options in the **Line Up** sub-menu, you can line up the top edges of the selected file boxes with the top edge of the file box that has the focus (when **Horizontally** is selected) or the left edges of the selected file boxes with the left edge of the file box that has the focus (when **Vertically** is selected).



To line up file boxes:

1. Select the file boxes you want to line up.
2. Select the menu option **Layout | Line Up** or right-click and select **Align | Line Up** from the context menu.
A sub-menu appears.
3. Select from this sub-menu, how you want to line up the selected file boxes.
Alternatively, skip step 2 and do one of the following:
 - Press **Alt+Down** or choose the **Vertically**  icon from the Alignment toolbar.
 - Press **Alt+Right** or choose the **Horizontally**  icon from the Alignment toolbar.

Changing the order of file boxes

If located in a stack of boxes you can bring a particular file box to top or bottom of this stack by selecting the corresponding option in the **Order** sub-menu.

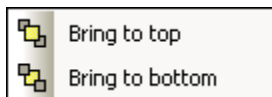

To bring a file box to the top or bottom of a stack of file boxes:

1. Select the file box you want to change the stack position of.
2. Select the menu option **Layout | Order** or right-click and select **Align | Order** from the context menu.
A sub-menu appears.
3. Select the appropriate option from the sub-menu.
Alternatively, skip step 2 and do one of the following:
 - Choose the **Bring to Top**  icon from the Alignment toolbar.

- Choose the **Bring to Bottom**  icon from the Alignment toolbar.

Resizing file boxes

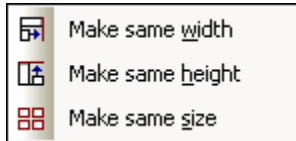

The **Resize** sub-menu provides several options to unify the appearance of file boxes in a design. The size to be applied to all selected file boxes is taken from the file box that has the focus.



Please note: Resizing height might require that components in a file box be collapsed in order to attain the height of the file box that has the focus.

To resize file boxes:

1. Select the file boxes you want to resize, giving focus to the file box whose size you want the others to be changed to.
2. Select the menu option **Layout | Resize** or right-click and select **Align | Resize** from the context menu.
A sub-menu appears.
3. Select the appropriate option from the sub-menu.
Alternatively, skip step 2 and do one of the following:

- Choose the **Make same width**  icon from the Alignment toolbar.
- Choose the **Make same height**  icon from the Alignment toolbar.
- Choose the **Make same size**  icon from the Alignment toolbar.

Distributing file boxes evenly

Within a selection of at least three file boxes, you can use the options provided in the **Space Evenly** sub-menu to arrange the files in a way that the space between them is equally distributed.

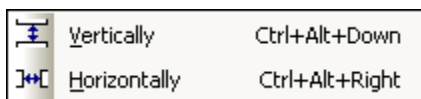

To space file boxes evenly:

1. Select three or more file boxes in a design.
2. Select the menu option **Layout | Space Evenly** or right-click and select **Align | Space Evenly** from the context menu.
A sub-menu appears.
3. Select the appropriate option from the sub-menu.
Alternatively, skip step 2 and do one of the following:
 - Press **Ctrl+Alt+Down** or choose the **Space evenly vertically**  icon from the Alignment toolbar.

- Press **Ctrl+Alt+Right** or choose the **Space evenly horizontally**  icon from the Alignment toolbar.



Sorting Files in Designs

The Sort sub-menu provides options for sorting file boxes in alphabetical order or according to their widths.





Please note: Alphabetical sorting is case-sensitive.

To sort file boxes by name:

1. Select the file boxes you want to sort.
2. Select the menu option **Layout | Sort** or right-click and choose **Sort | By Name** from the context menu.
A sub-menu appears.
3. Select the appropriate option from the sub-menu.
Alternatively, skip step 2 and do one of the following:
 - Choose the **Sort by Name ascending**  icon from the Sort toolbar.
 - Choose the **Sort by Name descending**  icon from the Sort toolbar.

To sort file boxes by width:

1. Select the file boxes you want to sort.
2. Select the menu option **Layout | Sort** or right-click and choose **Sort | By Width** from the context menu.
A sub-menu appears.
3. Select the appropriate option from the sub-menu.
Alternatively, skip step 2 and do one of the following:
 - Choose the **Sort by Width ascending**  icon from the Sort toolbar.
 - Choose the **Sort by Width descending**  icon from the Sort toolbar.

6.7.6 Connector Options

When you right-click a connector line in a Design window, different context menus open depending on the type of connector that has been clicked:

- When you right-click a **relation**, a context menu opens allowing you to select the source and/or target file, and to delete the relation.

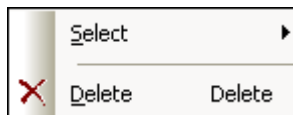

- For **component relations**, the context menu enables you to select the source and/or target file, and to show the relation path, that is, select the corresponding IIR relation as well as the respective file boxes.

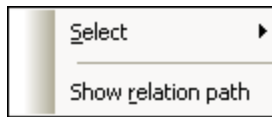

- The **Select** sub-menu is the same for both types of relation.



To select source and/or target file boxes for a relation:

- Right-click an IIR relation or a component relation and select one of the following options from the **Select** sub-menu of the context menu:
 - **Source**
 - **Target**
 - **Source & Target**

The corresponding file boxes are selected in the Design window.

To delete an IIR relation:

1. Do one of the following:
 - Right-click an IIR connector line and select **Delete** from the context menu.
 - Select an IIR connector line and press the **Delete** button.
 - Select an IIR connector line and click the **Delete**  icon in the Standard toolbar.A message box appears asking whether you really want to delete the selected objects.
2. To confirm the deletion, click **Yes**.

To show the relation path of a component relation:

- Right-click the connector line of a component relation and select **Show relation path** from the context menu.

SchemaAgent will select the connector lines between the related components as well as the the connector line showing the type of relation between the schemas. If the schema box of the source or target component is collapsed, it will be expanded to the level required to display the relation.

6.7.7 Printing Designs

The Design diagram in the active Design window can be printed together with a header and footer that provides meta information about the user environment and SchemaAgent application information.

A print preview is available for you to check the layout of the printed page before sending it to the printer.

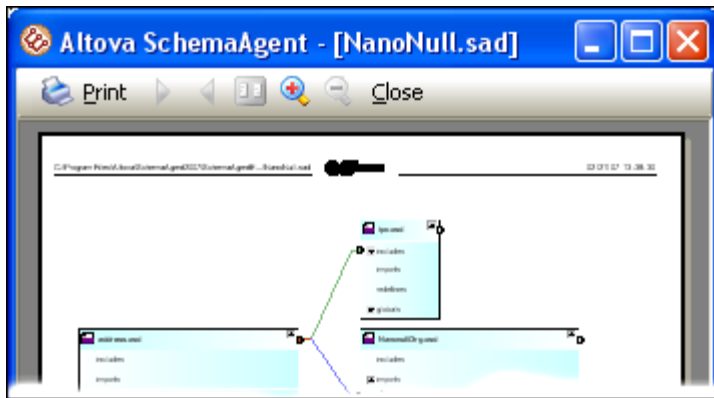

To print a design:

1. Select the design you want to print.
2. Select the menu option **File | Print...**, or press **Ctrl+P**, or click the **Print**  icon in the Standard toolbar.
The **Print** dialog box appears.

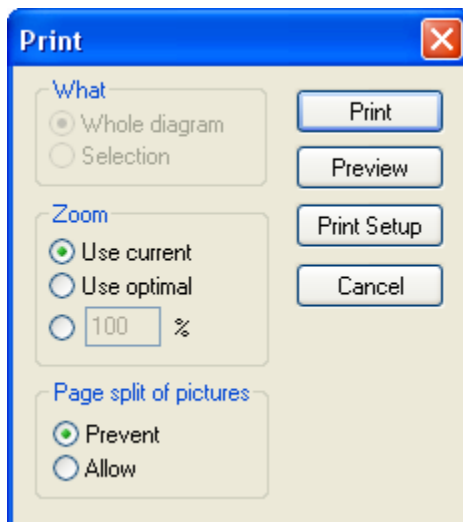

3. Choose the appropriate zoom factor in the Zoom group box.
The *Use optimal* option ensures that the design is printed on one page.
4. Optionally, define the printer setup by clicking the **Print Setup** button.
5. Optionally, click the **Preview** button to preview the print-out before actually sending it to the printer.
6. In the Page split of pictures group box, choose whether schema boxes may be split across page breaks.
7. Click **Print**.

To preview a design before printing:

1. Select the design you want to preview.
2. Select the menu option **File | Print Preview** or **File | Print...**, or press **Ctrl+P**, or click the **Print**  icon in the Standard toolbar.

The **Print** dialog box appears.

3. In the **Print** dialog box, click **Preview**.
4. In the print preview, do one of the following:
 - Click the **Print** button to print the file.
 - Click **Close** to return to the **Print** dialog box.

To change the printer setup:

1. Select the menu option **File | Print Setup**.
The **Print Setup** dialog box opens.
2. Adjust settings as desired and click **OK**.

6.7.8 Exporting Designs as Images

Designs that have been saved as PNG images can be opened with any picture viewer.

To export a design to a PNG image file:

1. Select the design you want to save as an image file.
2. Select the menu option **File | Export to image...**.
The standard Windows **Save As** dialog box appears.
3. Select the folder where you want to save the image.
4. Enter the file name for the image.
5. Click **Save**.

6.8 Designing IIR Relationships

XML schemas provide three main methods of modularizing your schemas: Imports, Includes, and Redefines, which we collectively call IIRs for short. Each of these methods has specific namespace requirements, which are automatically checked by SchemaAgent when you create IIRs in SchemaAgent Client.

IIRs are used as follows:

- **Includes** are used to incorporate schema components that belong to the same target namespace or that do not have a target namespace. In the SchemaAgent default color scheme, Includes appear as green lines.
- **Imports** are used when combining schema components that belong to different namespaces. Using Import defines the schema location, as well as the namespace for the schema. This allows the document instance to contain both namespaces. In the SchemaAgent default color scheme, Imports appear as blue lines.
- **Redefines** are used to combine and modify schema components of the same target namespace or that do not have a target namespace. Using Redefines allows you to incorporate external schema definitions and declarations, such as `complexType`, and change them in the redefining schema. In the SchemaAgent default color scheme, Redefines appear as purple-violet lines.

In SchemaAgent's Design window, you can easily [create](#) or [modify](#) IIR relationships between schemas using drag-and-drop. Please note that you cannot create a new schema file from scratch in SchemaAgent; you have, however, the possibility to [add a new file in the Explorer window](#) and then use the context menu to [edit the schema](#) in XMLSpy.

Please note: Connectors appear as soon as a schema is inserted into the design if the inserted schema has existing IIR relationships with other schemas present in the design.

6.8.1 Creating IIR Relations

Once you have [dragged a schema](#) into a Design window, you can create includes, imports, and redefines by adding the referenced schemas to the design and using drag-and-drop. To this aim, each schema or MFD file box has a handle located at the right border of the title bar.

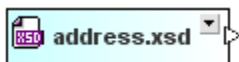

Clicking the schema box handle and dragging the cursor to the schema in which the IIR statement is to appear creates an IIR relation between the two schemas. The target schema will automatically expand to display the IIR entries when the cursor is positioned over the schema box. SchemaAgent automatically checks namespaces and highlights permissible relations in the target schema box when you place the cursor over the corresponding entry. This ensures that no invalid IIR statement is created in the target schema.

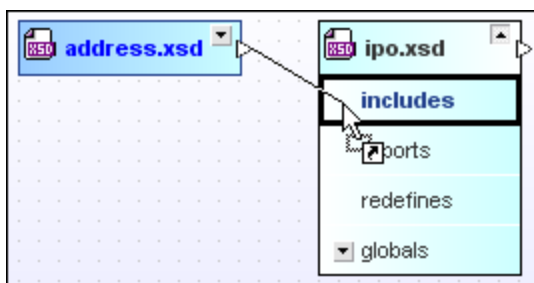

Releasing the mouse button when the cursor is positioned over the desired section of the target schema creates an Include, Import, or Redefine relation. When dropping the connector onto an entry that does not turn bold, an error message appears, explaining why the selected IIR

relationship is not allowed.

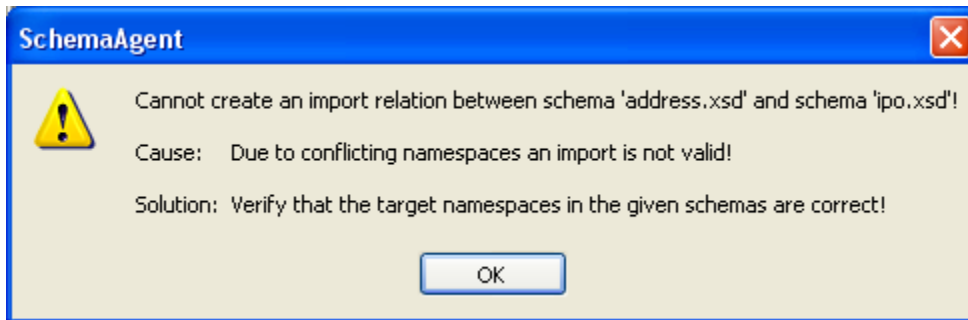

To create an IIR relation:

1. Click the schema box handle of the schema from which you wish to create the IIR and drag the cursor to the schema in which the IIR statement is to appear. If minimized, the target schema box expands, allowing you to drop the connector onto one of the IIR entries.
2. Place the cursor over the desired IIR entry.
3. When the desired IIR entry turns bold and a frame appears around it, drop the connector. The IIR command has now been inserted in the schema, and a drop-down symbol appears next to the IIR entry.
4. Optionally, create additional IIR relationships that are allowed between schemas.

6.8.2 Moving IIR Relationships

Existing IIR Includes, Imports, and Redefines can be moved from one schema box to another using drag-and-drop. Simply click the connector line and drag it to the appropriate section of a different schema box. If the relationship with the new schema is not valid, a message box to this effect pops up and the relation remains unchanged.

To move an existing IIR relationship:

1. Click the connector line of the IIR relation you wish to move and drag the cursor to the schema in which the IIR statement is to appear instead. If minimized, the target schema box expands, allowing you to drop the connector onto one of the IIR entries.
2. Place the cursor over the desired IIR entry.
3. When the desired IIR entry turns bold and a frame appears around it, drop the connector. The IIR command has now been inserted in the schema, and a drop-down symbol appears next to the IIR entry.

6.8.3 Deleting IIR Relationships

Unwanted Includes, Imports, and Redefines can be deleted in a Design window. If a given relation cannot be deleted, a message box pops up stating the reason of and offering a solution for the failure.

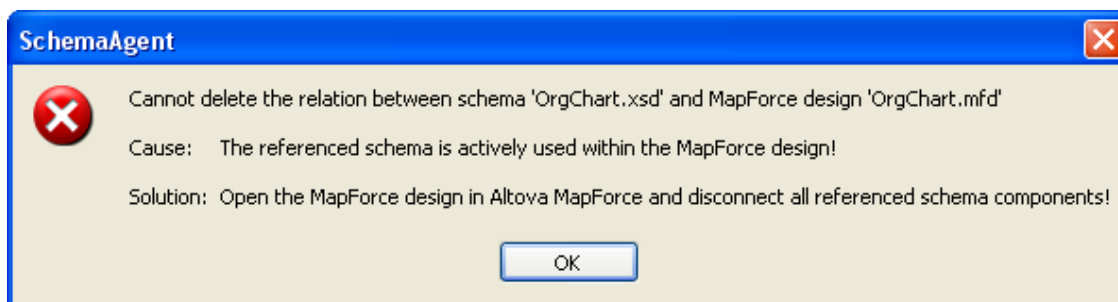
**To delete an IIR relation:**

1. Do one of the following:
 - Right-click an IIR connector line and select **Delete** from the context menu.
 - Select an IIR connector line and press the **Delete** button.
 - Select an IIR connector line and click the **Delete**  icon in the Standard toolbar.A message box appears asking whether you really want to delete the selected objects.
2. To confirm the deletion, click **Yes**.

6.9 User Reference

The **User Reference** section contains a complete description of all SchemaAgent Client menu commands. We've tried to make this user manual as comprehensive as possible. If, however, you have questions which are not covered in the User Reference or other parts of this documentation, please look up the FAQs and Discussion Forums on the Altova website. If you are still not able to have your problem satisfactorily addressed, please do not hesitate to contact us through the Support Center on the Altova website.

Note that in the [File](#) and [Edit](#) menus, all standard Windows commands are supported.

6.9.1 File Menu

The **File** menu contains all commands relevant to manipulating files, in the order common to most Windows software products.

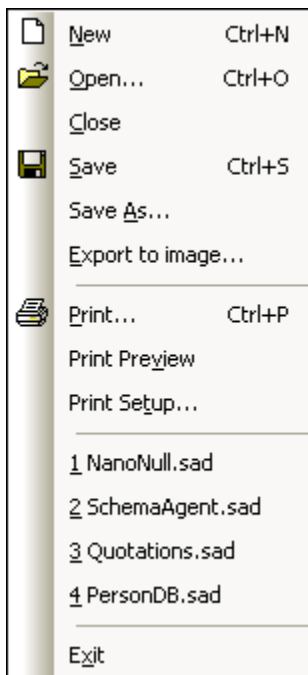

In addition to the standard [New](#), [Open](#), [Save](#), [Print](#), [Print Setup](#), and [Exit](#) commands, SchemaAgent Client offers also application-specific commands.

New



The **New** command opens a new [Design window](#).

Open...



The **Open...** command pops up the familiar Windows **Open** dialog box and allows you to open any design file (*.sad). In the **Open** dialog box, you can select more than one file to open. Use the **Files of Type** combo box to restrict the kind of files displayed in the dialog box.

Close

The **Close** command closes the active window. If the file was modified (indicated by an asterisk * after the file name in the title bar), you will be asked if you wish to save the file first.

Save



Ctrl+S

The **Save** command saves the contents of the active window to the file from which it has been opened. If the active window contains a new file, the [Save As...](#) dialog box is opened automatically.

Save As...

The **Save As...** command pops up the familiar Windows **Save As** dialog box, in which you enter the name and location of the file you wish to save the active file as.

Export to image...

The **Export to image...** command pops up the familiar Windows **Save As** dialog box, in which you enter the name and location of the file you wish to export the active file to as PNG image.

Print...



Ctrl+P

The **Print...** command opens the **Print** dialog box, in which you can [select printer options](#) and [print the active file](#).

Print Preview

The **Print Preview** command opens the **Print** dialog box. Click the **Preview** button to display a print preview of the currently active document.

Print Setup

The **Print Setup...** command displays the printer-specific **Print Setup** dialog box, in which you specify such printer settings as paper format and page orientation. These settings are applied to all subsequent print jobs.

Most Recently Used Files

The **File** menu displays a list of the four most recently used files, with the most recently opened file shown at the top of the list. You can open any of these files by clicking its name. To open a file in the list using the keyboard, press **ALT+F** to open the **File** menu, and then press the number of the file you want to open.

Exit

The **Exit** command is used to quit SchemaAgent Client. If you have any open files with unsaved changes, you are prompted to save these changes. SchemaAgent Client also saves modifications to program settings and information about the most recently used files.

6.9.2 Edit Menu

The **Edit** menu contains commands for editing file boxes in the Design window.

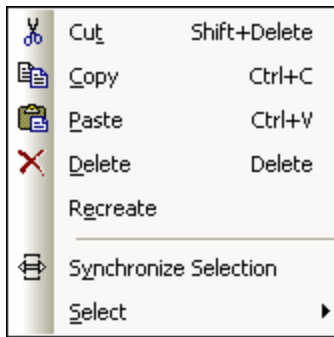

Cut



Shift+Delete

The **Cut** command copies the selected item to the clipboard and deletes it from its present location.

Copy



Ctrl+C

The **Copy** command copies the selected item to the clipboard. This can be used to duplicate data within SchemaAgent Client or to move data to another application.

Paste



Ctrl+V

The **Paste** command inserts the contents of the clipboard at the current cursor position.

Delete



Delete

The function of the **Delete** command depends on where the selected file is located and has the focus:

- If the focus is in a Design window, the selected file is removed from the design.
- If the focus is in the Explorer window, the selected file is deleted from the file system. You will have to confirm the command before the file is actually deleted.

Recreate

The **Recreate** commands creates a new file with the name of the ghost schema as a rudimentary schema at the location specified in the reference.

This command is only available if a [ghost schema](#) is selected either in the Explorer window or in a Design window.

Synchronize Selection



The **Synchronize Selection** command synchronizes the selected files in the Explorer and the active Design window. It works from both sides, that is, you can select a file in the Explorer and

use the command to select the corresponding file box in the active Design window or vice versa.

Please note: The **Synchronize Selection** command works only for the active Design window. If you select a file in the Explorer that is contained in a Design window that is not currently active, choosing the **Synchronize Selection** command has no effect.

Select

The **Select** sub-menu contains options for selecting schemas in the active Design window.

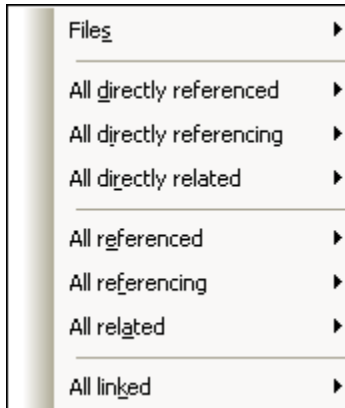

Files

Opens a sub-menu, from where you can select all files in the active Design window (**Ctrl+A**), or limit the selection to a specific file type.

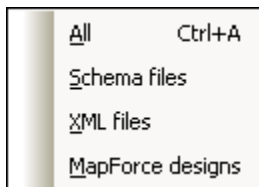

All directly referenced

Opens a sub-menu, from where you can select all files directly referenced by the selected file, or limit the selection of directly referenced files to a specific file type.

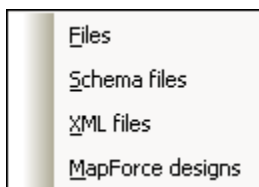

All directly referencing

Opens a sub-menu (identical to the **All directly referenced** sub-menu), from where you can select all files directly referencing the selected file, or limit the selection to a specific file type.

All directly related

Opens a sub-menu (identical to the **All directly referenced** sub-menu), from where you can select all files directly related to the selected file, or limit the selection to a specific file type.

All referenced

Opens a sub-menu (identical to the **All directly referenced** sub-menu), from where you can

select all files either directly or indirectly (because they are imported, included, or redefined by a directly referenced schema) referenced by the selected file, or limit the selection to a specific file type.

All referencing

Opens a sub-menu (identical to the **All directly referenced** sub-menu), from where you can select all files either directly or indirectly (because they are imported, included, or redefined by a directly referencing schema) referencing the selected file, or limit the selection to a specific file type.

All related

Opens a sub-menu (identical to the **All directly referenced** sub-menu), from where you can select all files either directly or indirectly (because they are imported, included, or redefined by a directly related schema) related to the selected file, or limit the selection to a specific file type.

All linked

Selects all files or files of a specific file type, respectively, that are linked with the selected file in any way, be it via a direct or indirect reference or because a referenced file serves as an input or output file for an MFD file.

6.9.3 View Menu

The **View** menu contains commands for showing and hiding the individual toolbars and the status bar.

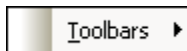

Toolbars

The **Toolbars** sub-menu enables you to show or hide the individual toolbars by activating or deactivating the corresponding entry in the menu.



To switch the display of toolbars on or off:

1. Select the menu option **View | Toolbars**.
2. Click the name of the toolbar you want to switch on or off.

Status Bar

The **Status Bar** command toggles the display of the status bar in SchemaAgent Client on and off.

To switch the display of the status bar on or off:

- Select the menu option **View | Status Bar**.

6.9.4 Layout Menu

The **Layout** menu provides a variety of features for changing the appearance of your designs.

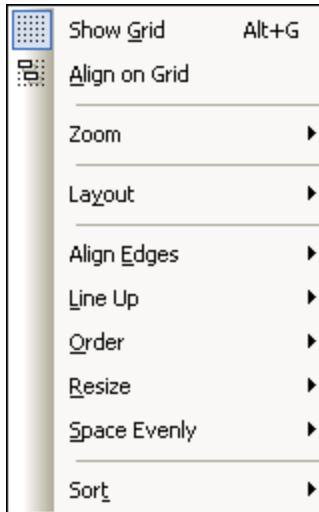

Show Grid



The **Show Grid** command toggles the display of the grid on and off for the active Design window. You can show or hide the grid for each Design window individually.

Align on Grid



When the [grid is displayed](#), you can use the **Align on Grid** command to align the top and left edges of schema or MFD file boxes on the grid.

Zoom

The **Zoom** sub-menu provides commands for zooming in and out of a design view as well as adjusting the zoom in a way that all file boxes or the selected file boxes are displayed in the Design window.

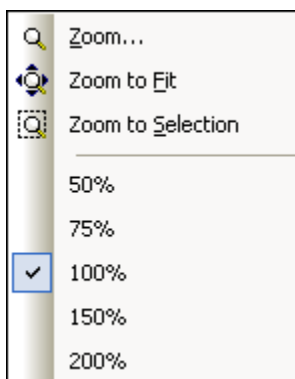

In order to adjust the zoom to one of the predefined values, simply select one of the options at

the bottom of the menu.



Zoom...

Shows the Zoom dialog box, where you can use the slider to adjust the zoom or enter a specific zoom factor.

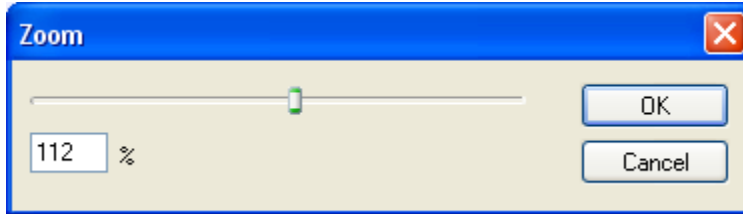

Zoom to Fit

Adjusts the zoom factor in a way that all file boxes that are present in the active design are displayed in the Design window without the need of scrolling.



Zoom to Selection

Adjusts the zoom factor in a way that all the selected file boxes are displayed in the Design window without the need of scrolling.

Layout

The **Layout** sub-menu provides commands that facilitate an automatic layout of the file boxes in a Design window.

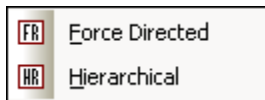

Force Directed

Uses a force-directed algorithm to automatically layout the file boxes in a Design window. You may have to use the [Zoom to Fit](#) command to view all the file boxes.

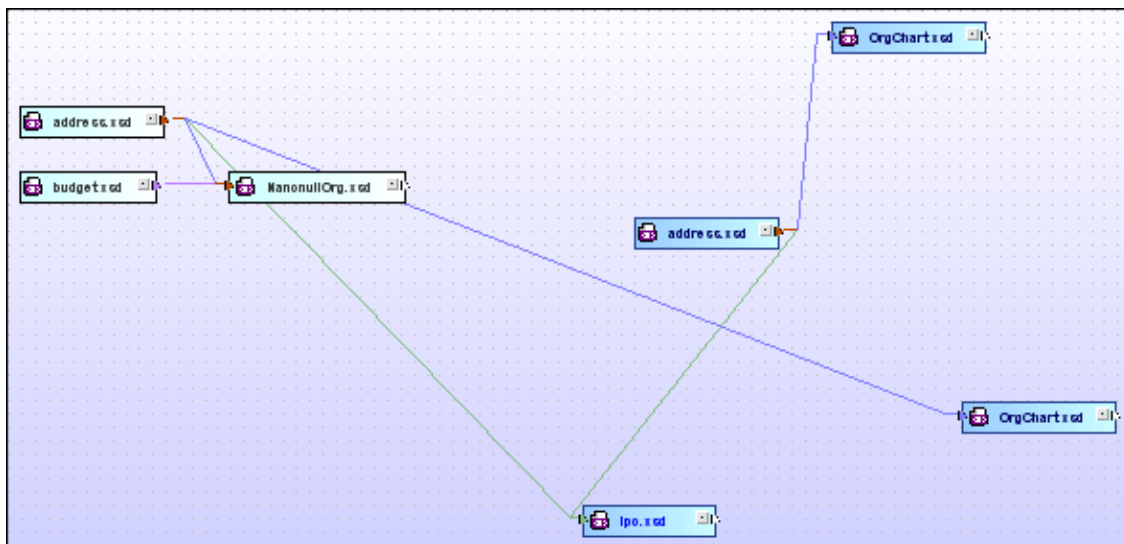



Hierarchical

Lays out the file boxes in a hierarchical manner.

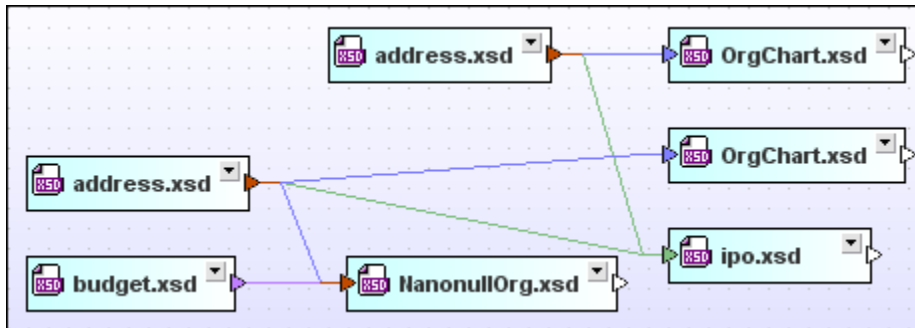

Align Edges

The **Align Edges** sub-menu can be used to align selected file boxes on the grid of a Design window.

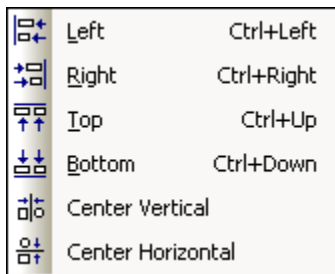

When selecting files for aligning, make sure that the focus is set on the right file box because all the files will be aligned with the file box that has the focus.



Left (Ctrl+Left)

Aligns the left edges of the selected file boxes. The selected file boxes will be left-aligned at the position of the file box that has the focus.



Right (Ctrl+Right)

Aligns the right edges of the selected file boxes. The selected file boxes will be right-aligned at the position of the file box that has the focus.



Top (Ctrl+Up)

Aligns the top edges of the selected file boxes. The selected file boxes will be aligned at the position of the top edge of the file box that has the focus.



Bottom (Ctrl+Down)

Aligns the bottom edges of the selected file boxes. The selected file boxes will be aligned at the position of the bottom edge of the file box that has the focus.



Center Vertical

Aligns the vertical center of the selected file boxes. The center of the selected file boxes will be aligned vertically at the position of the file that has the focus.

**Center Horizontal**

Aligns the horizontal center of the selected file boxes. The center of the selected file boxes will be aligned horizontally at the position of the file that has the focus.

Line Up

The **Line Up** sub-menu allows you to line up the selected file boxes vertically or horizontally below or to the right of the focused item.

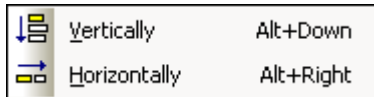
**Vertically (Alt+Down)**

Arranges the selected file boxes in a vertical row, left-aligned and below the file box that has the focus.

**Horizontally (Alt+Right)**

Arranges the selected file boxes in a horizontal row, top-aligned and to the right of the file box that has the focus.

Order

The **Order** sub-menu allows you to bring the selected file box to the top or send it to the bottom of a stack of file boxes.

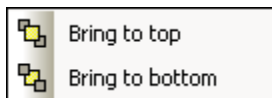
**Bring to top**

Displays the selected file box on top of a stack of file boxes.

**Bring to bottom**

Sends the selected file to the bottom of a stack of file boxes.

Resize

The **Resize** sub-menu provides options allowing you to unify the graphical appearance of your design files.

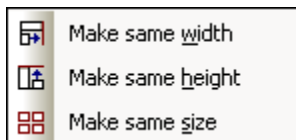

Be sure to choose the right file when setting the focus. All selected files inherit the dimensions of the file that has the focus.

**Make same width**

Applies the width of the focused file box to all selected file boxes.

**Make same height**

Applies the height of the focused file box to all selected file boxes.

**Make same size**

Applies the width and height of the focused item to all selected file boxes.

Space Evenly

The **Space Evenly** sub-menu allows you to distribute a series of selected file boxes evenly between the top and bottom or left and right edges of the selection, respectively.

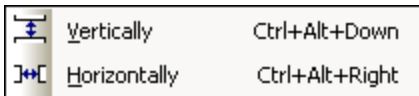

You can also use the commands subsequently to create a vertical and horizontal balance.

**Vertically (Ctrl+Alt+Down)**

Arranges the selected files to provide for an equal distance of the files located in between the topmost and the bottommost file boxes.

**Horizontally (Ctrl+Alt+Right)**

Arranges the selected files to provide for an equal distance of the files located in between the leftmost and the rightmost file boxes.

Sort

The **Sort** sub-menu allows you to sort file boxes by name or by width.

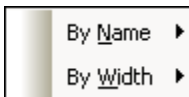

When you select one of the options, another sub-menu opens where you can choose ascending or descending sort order.



The positions of the selected file boxes (i.e., the top and left edges) remain unchanged when one of the **Ascending** or **Descending** commands is used.

Ascending

By Name: The selected file boxes are sorted alphabetically with the file name closest to letter A on top.



By Width: The selected file boxes are sorted by width with the smallest file box on top and the widest file box on bottom.

Descending

By Name: The selected file boxes are sorted alphabetically with the file name closest to

letter Z on top.



By Width: The selected file boxes are sorted by width with the widest file box on top and the smallest file box on bottom.

6.9.5 Extras Menu

In the **Extras** menu, you [connect](#) to a SchemaAgent Server, [reload](#) the search paths, and correct reference paths to ghost schemas for [selected](#) or [all](#) schema boxes.

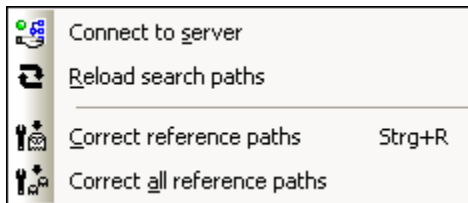

Connect to Server



The **Connect to server** command opens the **Connect to SchemaAgent Server** dialog box where you can connect to a SchemaAgent server.



Two connection options are available in this dialog box:

- **Work locally:** Starts and [connects to a local server](#) and adds the Configure Paths tab to the Explorer window.
- **Connect to network server:** [Connects to a SchemaAgent Server application](#) installed on your local machine or on a network server. The SchemaAgent Server must have been started before you are able to connect to it.

Reload Search Paths

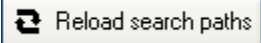

The **Reload search paths** command allows you to update the display of the files in your search paths at any time, even if the  button is not available in the Configure Paths tab of the Explorer or in SchemaAgent Server, respectively.

Correct Reference Paths



Ctrl+R

The **Correct reference paths** command attempts to [find alternative locations](#) for referenced files that cannot be found at the location specified in the IIR relation of a selected schema box. You have to select a schema box with an alert  icon in a Design window or in the Explorer in order to enable this command in the **Extras** menu. The **Correct reference paths** command brings up the **Correct reference path** dialog box.

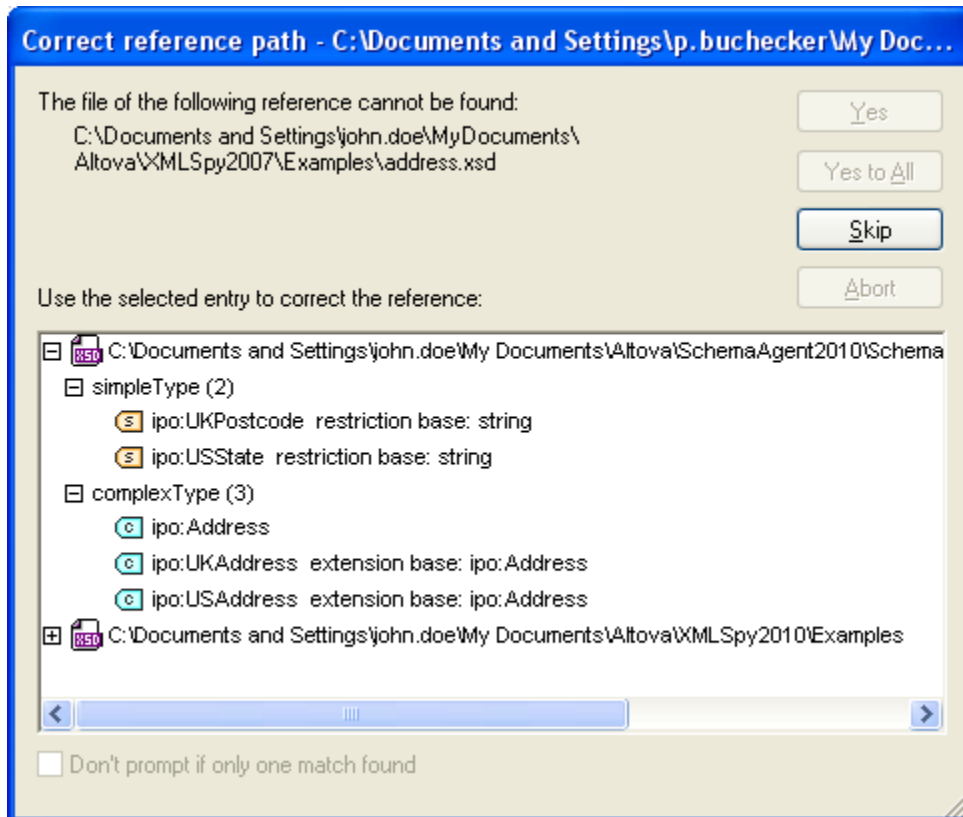

Correct All Reference Paths



The **Correct all reference paths** command attempts to [find alternative locations](#) for all referenced files that cannot be found at the location specified in the IIR relation in any of the schemas present in the search paths of SchemaAgent. This command brings up the **Correct all references to non-existing files** dialog box.

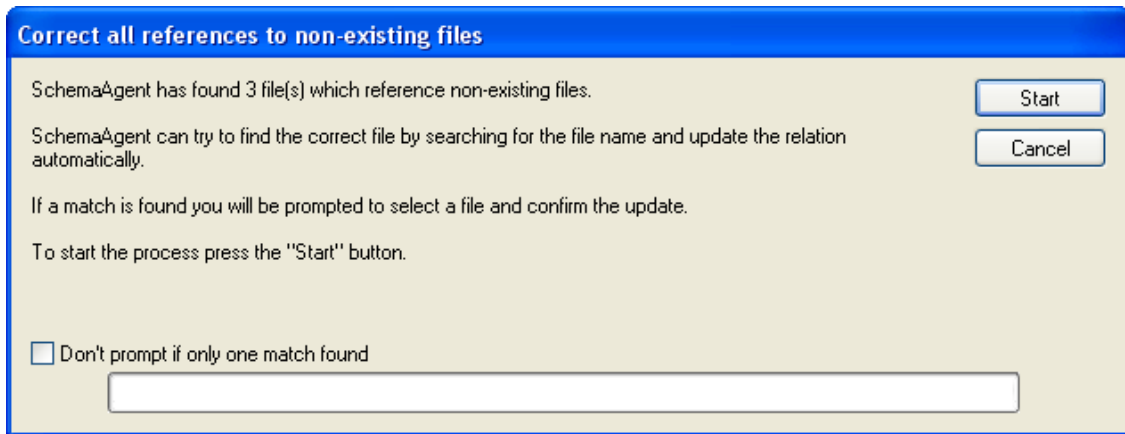

6.9.6 Tools Menu

The Tools menu allows you to [customize](#) your version of SchemaAgent Client and define the global program [settings](#).

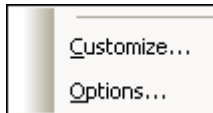

Customize...

The **Customize** command lets you customize SchemaAgent Client to suit your personal needs.

Commands

The **Commands** tab allows you customize your menus or toolbars.

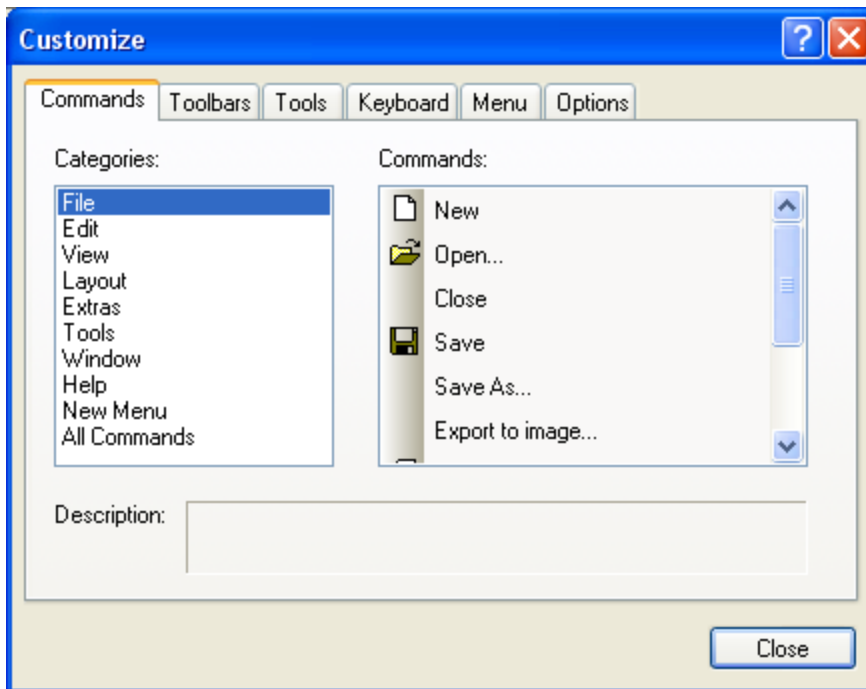

To add a command to a toolbar or menu:

1. Select the menu option **Tools | Customize**.
The **Customize** dialog box appears.
2. Select the `All Commands` category in the Categories list box.
The available commands appear in the Commands list box.
3. Click on a command in the Commands list box and drag it to an existing menu or toolbar.
An **I**-beam appears when you place the cursor over a valid position to drop the command.
4. Release the mouse button at the position you want to insert the command.
 - A small button appears at the tip of mouse pointer when you drag a command. The "x" below the pointer means that the command cannot be dropped at the current cursor position.
 - The "x" disappears whenever you can drop the command (over a tool bar or menu).
 - Placing the cursor over a menu when dragging opens it, allowing you to insert the command anywhere in the menu.
 - Commands can be placed in menus or toolbars. If you created your own toolbar you can populate it with your own commands/icons.

Please note: You can also edit the commands in the [context menu](#) (right-click anywhere to open the context menu), using the same method. Click the Menu tab and then select the specific context menu available in the Context Menus combo box.

Toolbars

The **Toolbars** tab allows you to activate or deactivate specific toolbars, as well as create your own specialized ones.

SchemaAgent Client toolbars contain symbols for the most frequently used menu commands. For each symbol you get a brief "tool tip" explanation when the mouse cursor is directly over the item and the status bar shows a more detailed description of the command.

You can drag the toolbars from their standard position to any location on the screen, where they appear as a floating window. Alternatively, you can also dock them to the left or right edge of the main window.

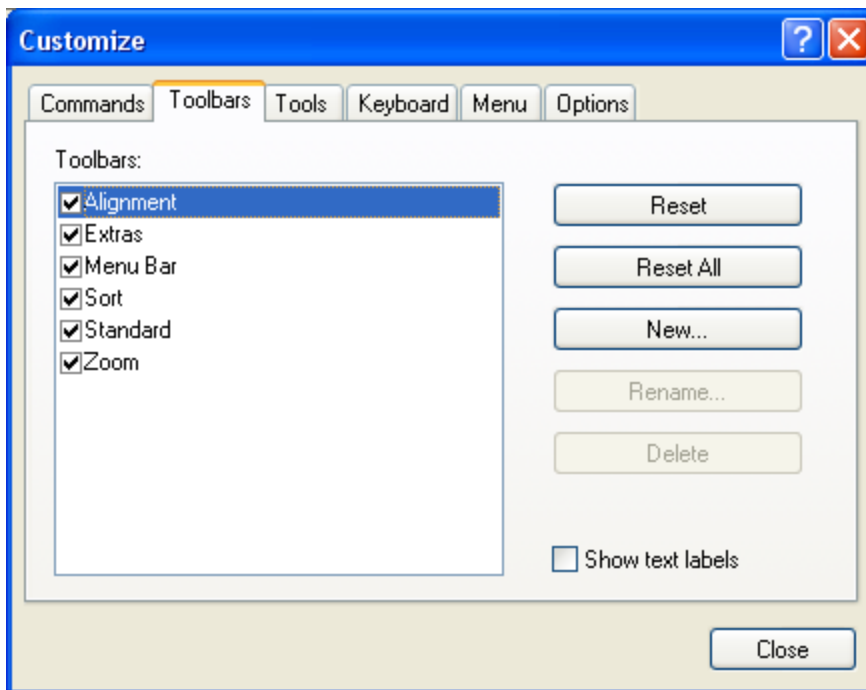
**Show text labels:**

This option displays explanatory text below toolbar icons when activated. You can activate or deactivate this option for each toolbar individually.

To activate or deactivate a toolbar:

- Click the check box to activate (or deactivate) the specific toolbar.

To create a new toolbar:

1. Click the **New...** button, and give the toolbar a name in the **Toolbar Name** dialog box that appears.
2. Drag commands to the toolbar in the [Commands](#) tab of the **Customize** dialog box.

To reset the Menu Bar:

1. Click the Menu Bar entry.
2. Click the **Reset** button, to reset the menu commands to the state they were in when SchemaAgent Client was installed.

To reset all toolbar and menu commands:

1. Click the **Reset All** button to reset all the toolbar commands to the state they were when the program was installed.
A prompt appears stating that all toolbars and menus will be reset.
2. Click **Yes** to confirm the reset.

To change a toolbar name:

- Click the **Rename...** button to edit the name of the toolbar.

This option is available only for user-defined toolbars.

To delete a toolbar:

1. Select the toolbar you want to delete in the Toolbars list box.
2. Click the **Delete** button.
A prompt appears, asking if you really want to delete the toolbar.
3. Click **Yes** to confirm the deletion.

This option is available only for user-defined toolbars.

Tools

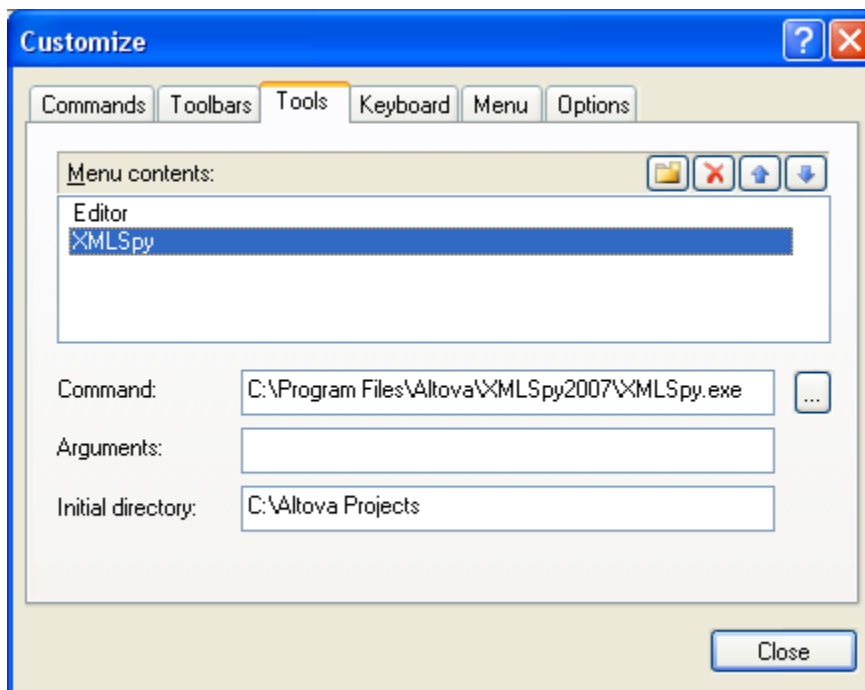

The **Tools** tab allows you to add your personal menu items, e.g., links to other applications, to the **Tools** menu.

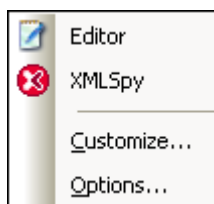

Any user-defined entries will appear above the standard menu items in the **Tools** menu.





To add a user-defined tool:

1. Click the **New**  icon in the Menu contents title bar or press the **Insert** key.
2. In the text field that appears, enter the string that is to appear as menu entry in the **Tools** menu.
3. In the **Command** field enter the path to the EXE file of the application or use the browse  button to select the path.
4. If applicable, enter arguments needed to start the application in the **Arguments** field.

5. Enter the path to the initial directory, if required.

To change the sequence of user-defined tools:

- Select an entry and use the **Move Item Up**  and **Move Item Down**  buttons to move the menu item.
Alternatively, you can also use the shortcut keys **Alt+Up** and **Alt+Down** to move the entry.

To rename a user-defined menu item:

- Double-click an item in the `Menu contents` field and edit the entry.

To remove a user-defined tool:

- Select the entry you want to remove from the Tools menu and click the **Delete**  icon in the Menu contents title bar or press the **Delete** key.

Keyboard

The **Keyboard** tab allows you to define (or change) keyboard shortcuts for any SchemaAgent Client command.

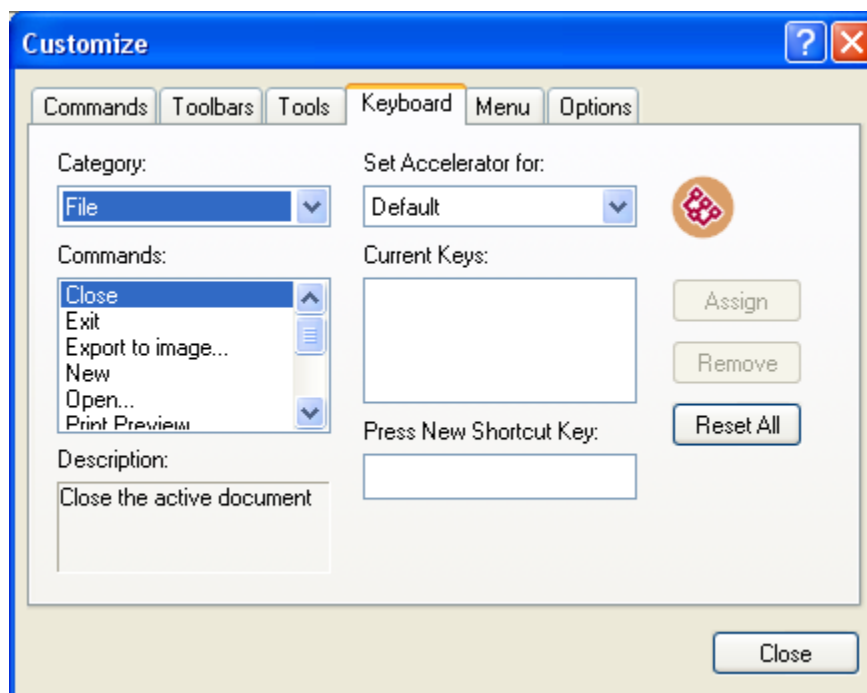

In the `Set accelerator` for drop-down list, you can differentiate between shortcuts that are valid in the Default menu or in the SchemaAgent Design menu.

To assign a new Shortcut to a command:

1. Select the All Commands category using the `Category` combo box.
2. Select the command you want to assign a new shortcut to, in the `Commands` list box.
3. Click in the `Press New Shortcut Key` text box, and press the shortcut keys that are to activate the command.
The shortcuts appear immediately in the text box. If the shortcut was assigned

previously, then that function is displayed below the text box.

4. Click the **Assign** button to assign the shortcut.
The shortcut now appears in the `Current Keys` list box.
(To clear this text box, press any of the control keys, **CTRL**, **ALT** or **SHIFT**).

To de-assign or delete a shortcut:

1. Click the shortcut you want to delete in the `Current Keys` list box.
2. Click the **Remove** button.
3. Click the **Close** button to confirm.

To reset all shortcut keys:

1. Click the **Reset All** button to reset all the shortcut keys to the state they were when the program was installed.
A prompt appears stating that all toolbars and menus will be reset.
2. Click **Yes** to confirm the reset.

Currently assigned keyboard shortcuts

Hotkeys by key

F1	Help
Delete	Delete
Shift+Delete	Cut
Ctrl+Insert	Copy
Shift+Insert	Paste
Ctrl+Down	Align Edges Bottom
Alt+Down	Line Up Vertically
Ctrl+Alt+Down	Space Evenly Vertically
Ctrl+Left	Align Edges Left
Ctrl+Right	Align Edges Right
Alt+Right	Line Up Horizontally
Ctrl+Alt+Right	Space Evenly Horizontally
Ctrl+Up	Align Edges Top
Ctrl+A	Select All
Ctrl+C	Copy
Ctrl+N	New
Ctrl+O	Open
Ctrl+P	Print
Ctrl+R	Correct Reference Paths
Ctrl+S	Save
Ctrl+V	Paste
Ctrl+X	Cut
Alt+G	Show Grid

Hotkeys by function

Align Edges Bottom	Ctrl+Down	
Align Edges Left	Ctrl+Left	
Align Edges Right	Ctrl+Right	
Align Edges Top	Ctrl+Up	
Copy	Ctrl+C	Ctrl+Insert
Correct Reference Paths	Ctrl+R	
Cut	Ctrl+X	Shift+Delete
Delete	Delete	
Help	F1	
Line Up Horizontally	Alt+Right	
Line Up Vertically	Alt+Down	
New	Ctrl+N	
Open	Ctrl+O	
Paste	Ctrl+V	Shift+Insert
Print	Ctrl+P	
Save	Ctrl+S	
Select All	Ctrl+A	
Show Grid	Alt+G	
Space Evenly Horizontally	Ctrl+Alt+Right	
Space Evenly Vertically	Ctrl+Alt+Down	

Menu

The **Menu** tab allows you to customize the main menu bars as well as the context menus.

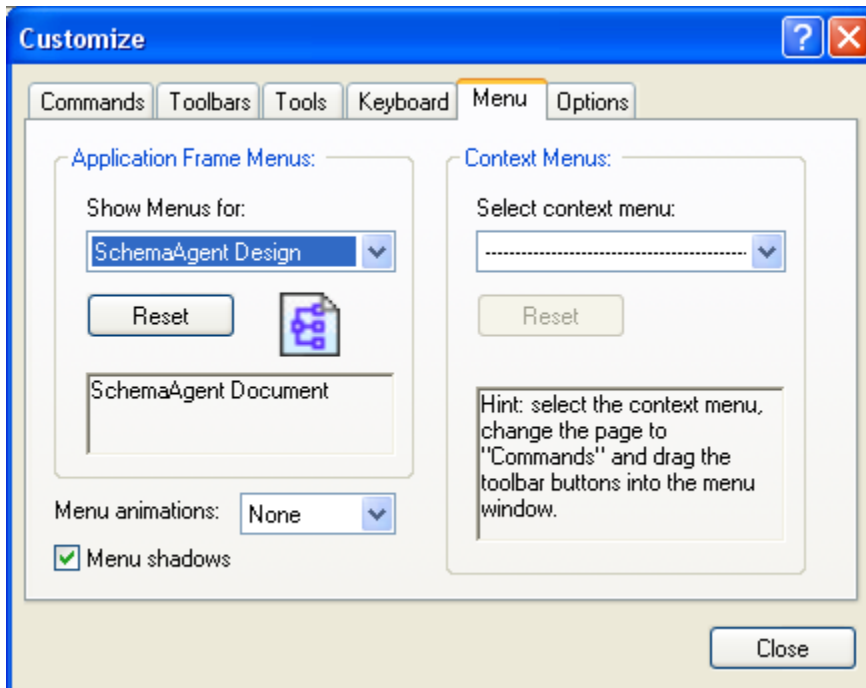

You can customize both the Default and SchemaAgent Design menu bars.

The Default menu is the one visible when no Design windows are open in SchemaAgent Client.

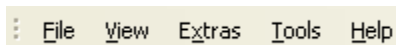

The SchemaAgent Design menu is the menu bar visible when at least one Design window has been opened.

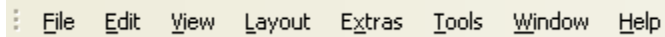

⋮ File Edit View Layout Extras Tools Window Help

Menu animations and menu shadows

You can choose from among several menu animations if you prefer animated menus. The `Menu animations` drop-down box provides the following options:

- None (default)
- Unfold
- Slide
- Fade

The `Menu shadows` check box, which is checked by default, can be deactivated if you do not want all your menus to have shadows.

To customize a menu:

1. Select the menu bar you want to customize from the `Show Menus for` combo box.
2. Click the [Commands](#) tab, and drag the commands to the menu bar of your choice.

To delete commands from a menu:

1. Select the menu option **Tools | Customize** to open the **Customize** dialog box.
2. Do one of the following:
 - Right-click the command or icon representing the command and select the **Delete** option from the context menu.
 - Drag the command away from the menu, and drop it as soon as the check mark icon appears below the mouse pointer.

To reset either of the menu bars:

1. Select either the **Default** or the **SchemaAgent Design** entry in the `Show Menus for` combo box.
2. Click the **Reset** button just below the menu name.
A prompt appears asking if you are sure you want to reset the menu bar.
3. Click **Yes**.

To customize any of the context menus (right-click menus):

1. Select the context menu from the `Select context menu` combo box.
The context menu you selected appears.
2. Click the [Commands](#) tab, and drag the commands to the context menu.

To delete commands from a context menu:

1. Select the menu option **Tools | Customize** to open the **Customize** dialog box.
2. Do one of the following:
 - Right-click on the command or icon representing the command and select the **Delete** option from the context menu.
 - Drag the command away from the context menu, and drop it as soon as the check mark icon appears below the mouse pointer.

To reset any of the context menus:

1. Select the context menu from the combo box.
2. Click the **Reset** button just below the context menu name.
A prompt appears asking if you are sure you want to reset the context menu.

To close a context menu window:

Do one of the following:

- Click on the **Close icon** at the top right of the title bar.
- Click the **Close** button of the **Customize** dialog box.

To change the appearance of menus:

1. If you want animated menus, select the appropriate option from the `Menu animations` drop-down box.
2. If required, deactivate the `Menu shadows` check box.

Options

The Options tab allows you to set general environment settings.

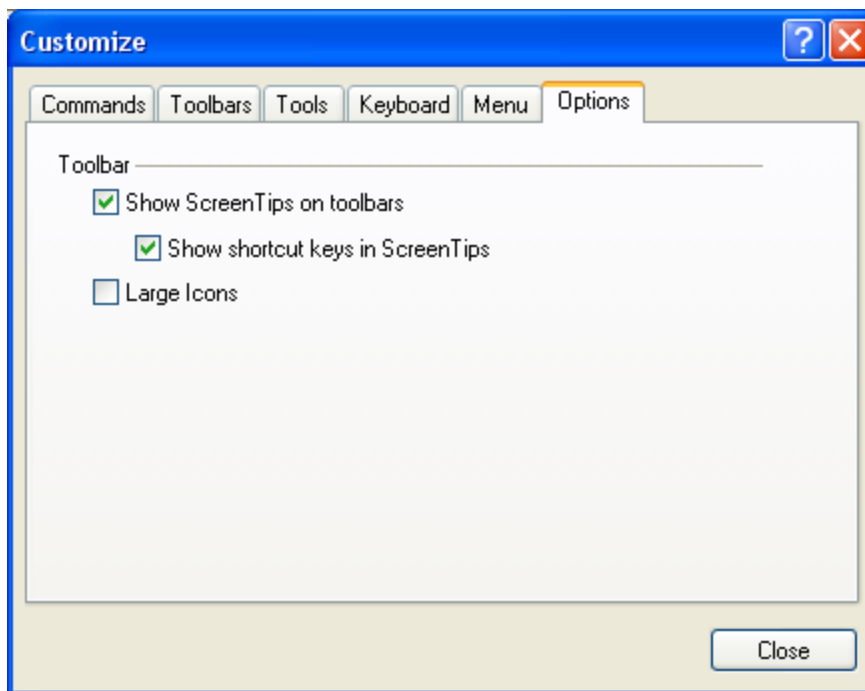
**Toolbar**

When active, the `Show ScreenTips on toolbars` check box displays a popup when the mouse pointer is placed over an icon in any of the icon bars. The popup contains a short description of the icon function, as well as the associated keyboard shortcut, if one has been assigned.

The `Show shortcut keys in ScreenTips` check box allows you to decide whether or not you want to have the shortcut displayed in the tooltip.

When active, the `Large icons` check box switches between the standard size icons, and

larger versions of the icons.

Options...

The **Tools | Options** command enables you to define global application settings. These settings are specified in a tabbed dialog box and saved in the registry. They apply to all current and future document windows. The **Apply** button in the **Options** dialog box displays the changes in the currently open documents and fixes the current settings. The changes are seen immediately in the background windows.

Each tab of the **Options** dialog box is described in detail in this section.

Design

The Design tab allows you to customize the way file boxes are presented in Design windows.

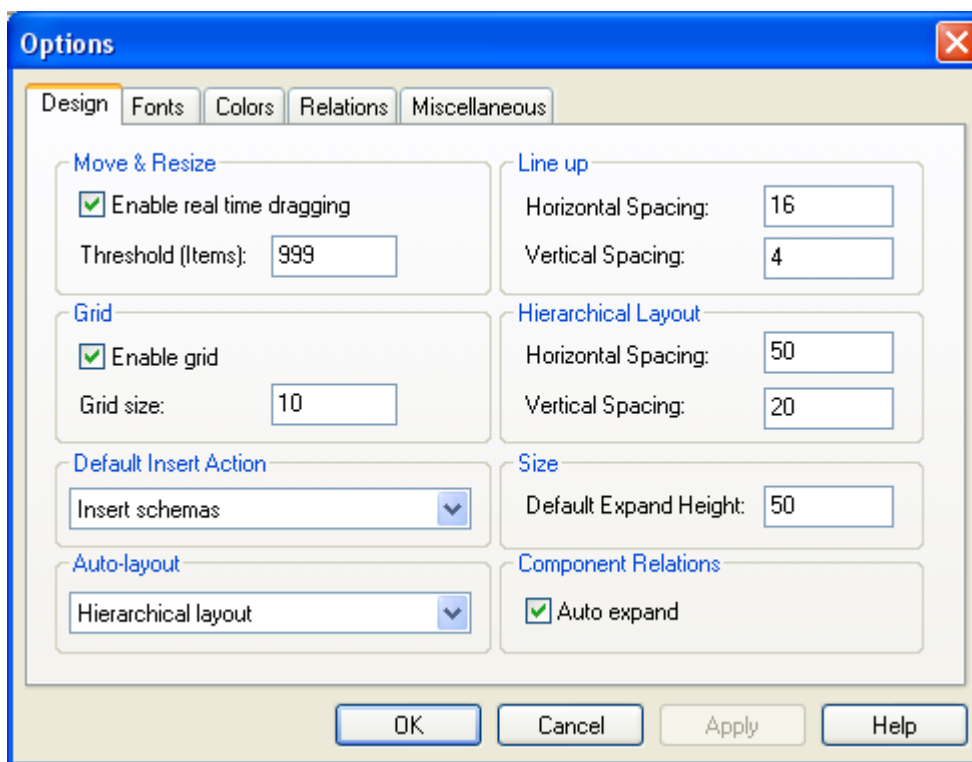

Move & Resize

If the `Enable real time dragging` check box is activated, the design is permanently redrawn while a file box is being dragged. If the check box is deactivated, the file box remains at its original position while the file box is being dragged, and moves to the new position only when the mouse button is released. While being dragged, the new position of the file box is shown in outline.

In the `Threshold (Items)` field, you can enter the maximum number of selected file boxes that are shown with its contents while being dragged. If the number of file boxes selected is above that limit, then the selected file boxes are shown in outline while being dragged.

Grid

The `Enable grid` check box sets the default appearance of new Design windows. Use the `Grid size` field to define the width of the grid. Please note that the settings of Design windows that are already open cannot be changed via the **Options** dialog box, you have to use the

Enable/Disable grid  icon in the Alignment toolbar or the shortcut key **Alt+G** to hide or display the grid for an active Design window.

Default Insert Action

The `Default Insert Action` drop-down box sets the default action for [inserting a file into a design](#) when it is dragged into the Design window. The following options are available:

- Selection only
- Selection and all directly referenced files
- Selection and all directly referenced schemas
- Selection and all directly referenced XML
- Selection and all directly referenced MapForce
- Selection and all directly referencing files
- Selection and all directly referencing schemas
- Selection and all directly referencing XML
- Selection and all directly referencing MapForce
- Selection and all directly related files
- Selection and all directly related schemas
- Selection and all directly related XML
- Selection and all directly related MapForce
- Selection and all referenced files
- Selection and all referenced schemas
- Selection and all referenced XML
- Selection and all referenced MapForce
- Selection and all referencing files
- Selection and all referencing schemas
- Selection and all referencing XML
- Selection and all referencing MapForce
- Selection and all related files
- Selection and all related schemas
- Selection and all related XML
- Selection and all related MapForce
- Selection and all linked files
- Selection and all linked schemas
- Selection and all linked XML
- Selection and all linked MapForce

Auto-layout

The following layout options are available when several files or entire folders are dragged into a design window:

- Default layout
- [Force-directed layout](#)
- [Hierarchical layout](#)

The `Default layout` option arranges the file boxes alphabetically in the design.

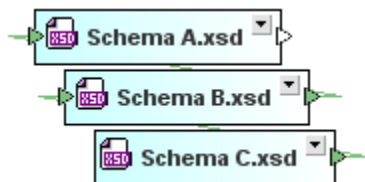

Line up and Hierarchical Layout

In the Line up and Hierarchical Layout group boxes, you can enter the default horizontal and vertical spacing for lining up file boxes or arranging them in the hierarchical layout, respectively.

Size

The default expand height is the height of a file box when it is expanded.

Component Relations

If the `Auto expand` check box is activated, SchemaAgent will automatically expand the details tree to the source and target component when you click on a component relation. Note that the globals section in both source and target schema have to be expanded in order to see the component relations.

Fonts

The Fonts tab allows you to customize the appearance of text in SchemaAgent designs. You can restore the default settings at any time by clicking the **Restore default values** button.

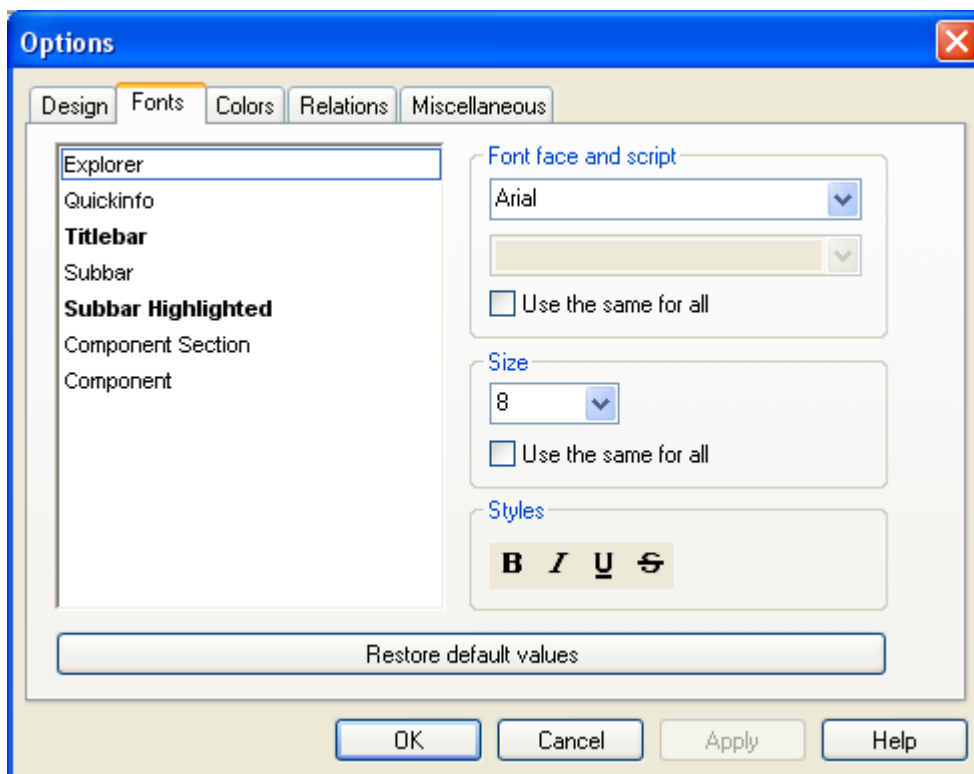

Font face and script

You can select the font face and size to be used for displaying the various items in the Design view. The same fonts are used when printing, so only TrueType fonts should be selected. If you want to use the same font for all items, click on the `Use the same for all` check box.

Size

Select the required size. If you want to use the same font size for all items, click on the `Use the same for all` check box.

Styles

The style and color can be set using the options in this group box. The current settings are immediately reflected in the list in the left pane, so you can preview the way your design will look.

Colors

The Colors tab enables you to customize the colors used in the Design window. You can restore the default settings at any time by clicking the **Restore default values** button.

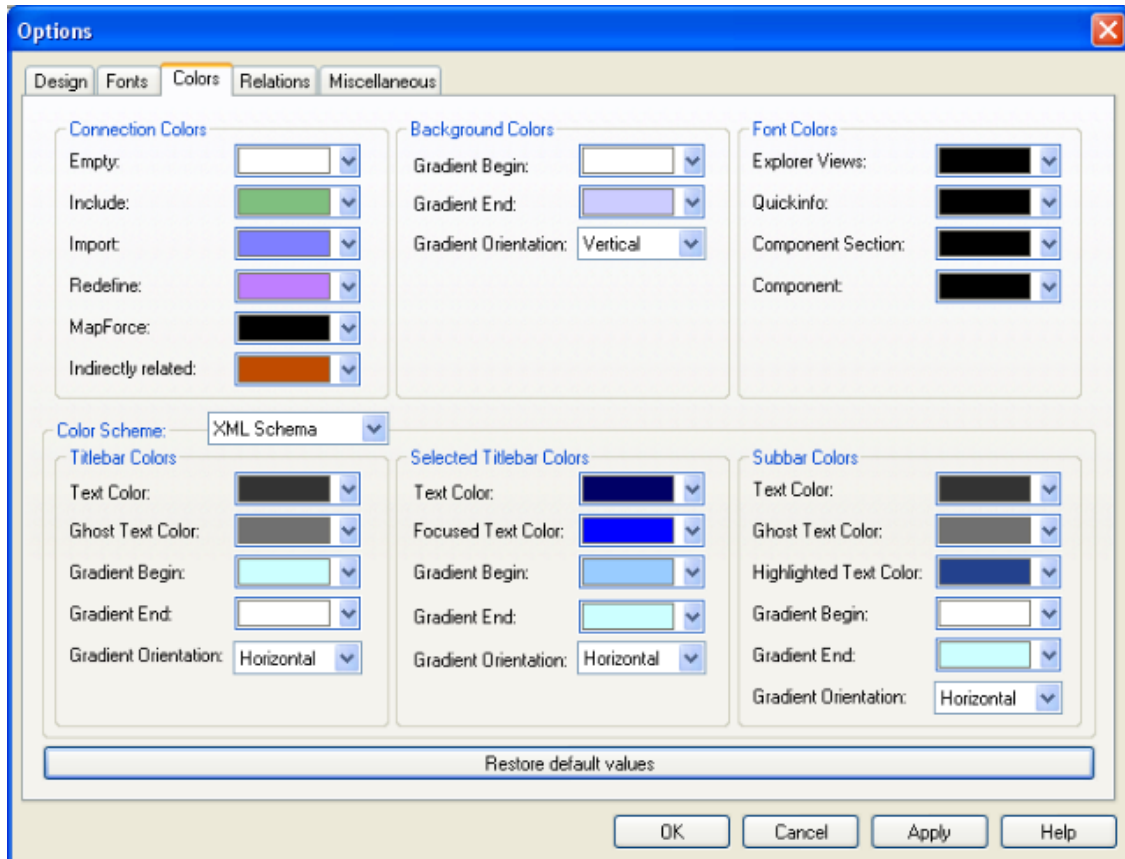

Background Colors

This group box allows you to define the colors for a gradient background as well as the orientation of the gradient.

Connector Colors

The color in the Connection Colors group box refers to the arrowheads to the left and right of a file box. You can define different colors for empty connectors and for connectors combining several different types of connections. The color of the connector lines itself is defined in the [Connection colors](#) group box.

Font Colors

Here you define the font color for the different types of text in SchemaAgent Client. The font itself as well as font size and style are defined in the [Fonts](#) tab.

Color Scheme

The Color Scheme group box provides a drop-down list where you can select either one of the following for editing:

- XML Schema
- XML instance
- Stylesheet Transformation
- Web Services Description
- MapForce Design

Individual group boxes are available where you can change the colors for the title bar when it is unselected or selected and the colors for the subbars, that is, the titles of the individual sections of a file box.

Connection Colors

The color in the Connection Colors group box refers to the connection line itself. Depending on the selection in the `Color Scheme` drop-down list, different options are available:

- XML Schema: Include, Import, Redefine
- XML Instance: Schema, Stylesheet
- Stylesheet Transformation: Include Stylesheet, Import Stylesheet, Import Schema, Inline Schema
- Web Services Description: Import WSDL, Import Schema, Inline Schema
- MapForce Design: Schema, Instance, WSDL

Relations

The Relations tab allows you to customize the appearance of the connection lines between file boxes in SchemaAgent designs. You can restore the default settings at any time by clicking the **Restore default values** button.

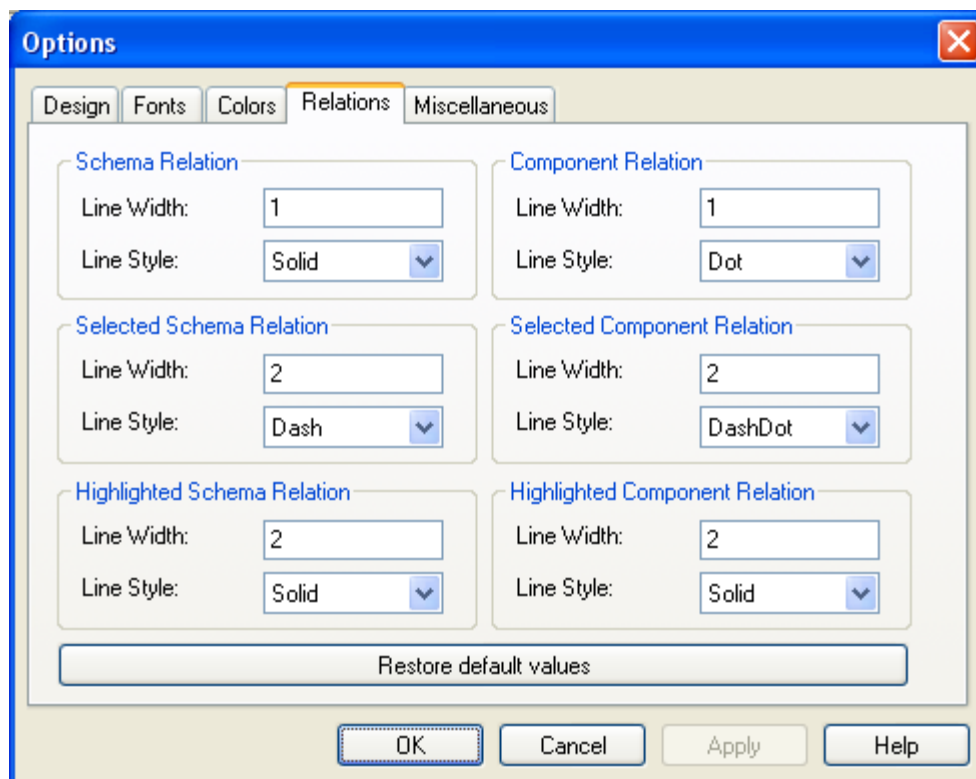

You can define the line width as well as the line style for both file and component relations in either of the following states:

- Normal
- [Selected](#)
- [Highlighted](#)

For the line width, you can enter integers between 1 and 10.

Miscellaneous

The Miscellaneous tab enables you to define startup and shutdown as well as caching options.

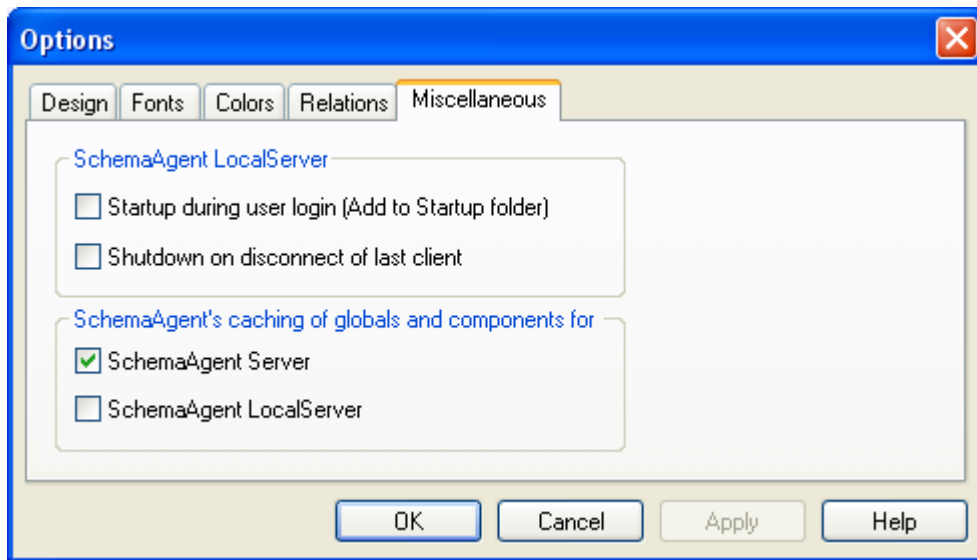

SchemaAgent LocalServer

You can add SchemaAgent LocalServer to the Windows Startup folder by activating the `Startup during user login (Add to Startup folder)` check box. In this case, SchemaAgent LocalServer will be started each time a user logs in to Windows.

If you activate the `Shutdown on disconnect of last client` check box, SchemaAgent LocalServer will automatically shutdown as soon as the last client disconnects from SchemaAgent Client.

SchemaAgent's caching of globals and components for

For each of the available servers, you can define whether or not data should be cached. If data is cached by a SchemaAgent server, more memory is used but communication frequency is lower.

6.9.7 Window Menu

To organize the individual windows in a SchemaAgent Client session, the **Window** menu contains standard commands common to most Windows applications.

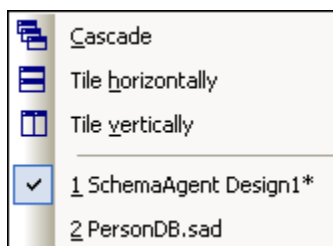

You can [cascade](#) the open windows, tile them [horizontally](#) or [vertically](#), or arrange document icons once you have minimized them. You can also [switch to an open Design window](#) directly from the menu.

Cascade



The **Cascade** command rearranges all open document windows so that they are all cascaded (i.e., staggered) on top of each other.

Tile Horizontally



The **Tile horizontally** command rearranges all open document windows as **horizontal tiles**, making them all visible at the same time.

Tile Vertically



The **Tile vertically** command rearranges all open document windows as **vertical tiles**, making them all visible at the same time.

Currently Open Window List

This list shows all currently open design windows and lets you quickly switch between them.

You can also use the **Ctrl+TAB** or **Ctrl+F6** keyboard shortcuts to cycle through the open windows.

6.9.8 Help Menu

The **Help** menu contains commands required to get help or more information on SchemaAgent, as well as links to information and support pages on our web server.

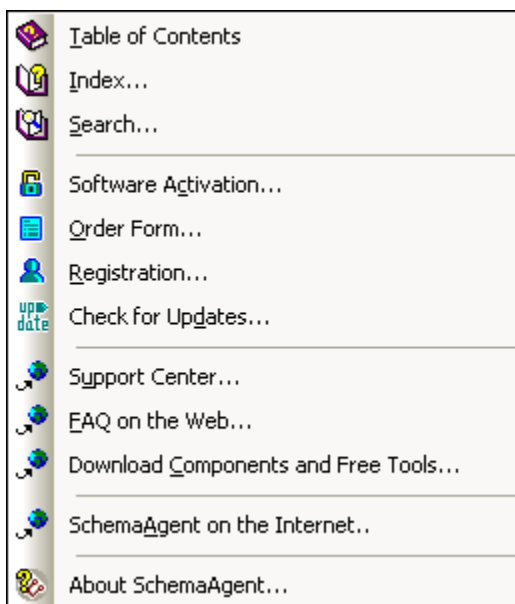

The **Help** menu also contains the [Registration](#) option, which brings you to the Altova website where you can enter your data and register your software with Altova.

Table of Contents



F1

The **Table of Contents** command displays a **hierarchical representation** of all chapters and topics contained in the online help system. Use this command to jump to the table of contents directly from within SchemaAgent.

Once the help window is open, use the three tabs to navigate between the table of contents, [index](#), and [search](#) panes. The Favorites tab lets you bookmark certain pages within the help system.

Index...



The **Index...** command accesses the **keyword index** of the Online Help. You can also use the Index tab in the left pane of the online help system.

The index lists all relevant keywords and lets you navigate to a topic by double-clicking the respective keyword. If more than one topic matches the selected keyword, you are presented a list of available topics to choose from.

Search...



The **Search** command performs a **full-text search** on the entire online help system.

1. Enter your search term in the query field and press **Enter**.
The online help system displays a list of available topics that contain the search term you've entered.
2. Double-click on any item in the list to display the corresponding topic.

Software Activation....



After you download your Altova product software, you can activate it using either a free evaluation key or a purchased permanent license key.

- **Free evaluation key.** When you first start the software after downloading and installing it, the **Software Activation** dialog box will pop up. In it is a button to request a free evaluation key-code. Enter your name, company, and e-mail address in the dialog that appears, and click **Request Now!** The evaluation key is sent to the e-mail address you entered and should reach you in a few minutes. Now enter the key in the key-code field of the **Software Activation** dialog box and click **OK** to start working with your Altova product. The software will be unlocked for a period of 30 days.
- **Permanent license key.** The **Software Activation** dialog box contains a button to purchase a permanent license key. Clicking this button takes you to Altova's online shop, where you can purchase a permanent license key for your product. There are two types of permanent license: single-user and multi-user. Both will be sent to you by e-mail. A single-user license contains your license-data and includes your name, company, e-mail, and key-code. A multi-user license contains your license-data and includes your company name and key-code. Note that your license agreement does not allow you to install more than the licensed number of copies of your Altova software on

the computers in your organization (per-seat license). Please make sure that you enter the data required in the registration dialog exactly as given in your license e-mail.

Note: When you enter your license information in the **Software Activation** dialog box, ensure that you enter the data exactly as given in your license e-mail. For multi-user licenses, each user should enter his or her own name in the Name field.

The **Software Activation** dialog box can be accessed at any time by clicking the **Help | Software Activation** command.

Registration...

The first time you start your Altova software after having activated it, a dialog box appears asking whether you would like to register your product. There are three buttons in this dialog box:

- **OK:** Takes you to the Registration Form
- **Remind Me Later:** Pops up a dialog box in which you can select when you wish to be next reminded.
- **Cancel:** Closes the dialog box and suppresses it in future. If you wish to register at a later time, you can use the **Help | Registration...** command.

Check for Updates...



Checks with the Altova server whether a newer version than yours is currently available and displays a message accordingly.

Support Center...

If you have any questions regarding our product, please feel free to use this command to send a query to the Altova Support Center at any time. This is the place where you'll find links to the FAQ, support form, and e-mail addresses for contacting our support staff directly.

FAQ on the Web...

To help you in getting the best support possible, we are providing a list of Frequently Asked Questions (FAQ) on the Internet, that is constantly updated as our support staff encounters new issues that are raised by our customers.

Please make sure to check the FAQ before contacting our technical support team. This will allow you to get help more quickly.

We regret that we are not able to offer technical support by phone at this time, but our support staff will typically answer your e-mail requests within one business day.

If you would like to make a feature suggestion for a future version of SchemaAgent Client or if you wish to send us any other general feedback, please use the questionnaire form.

Download Components and Free Tools...

This command is a link to the Components Download page at the Altova website, from where you can download components, free tools, and third-party add-ins. Such software ranges from XSLT and XSL-FO processors to Application Server Platforms.

SchemaAgent on the Internet...

The **SchemaAgent on the Internet** command takes you directly to the [Altova web-server](#) where you can find out about news, product updates and additional offers from the Altova team.

About SchemaAgent

The **About SchemaAgent** command shows the SchemaAgent splash screen and copyright information dialog box, which includes the version number of your product and the SchemaAgent logo. If you are using the 64-bit version of SchemaAgent, this is indicated with the suffix (x64) after the application name. There is no suffix for the 32-bit version.

Chapter 7

XMLSpy and SchemaAgent

7 XMLSpy and SchemaAgent

Altova's XMLSpy product (Enterprise or Professional edition) can use SchemaAgent technology to provide powerful schema editing functionality. When XMLSpy has been set up to work with SchemaAgent, schemas, XML files, XSL and XSLT files, and WSDL files can be directly edited in XMLSpy using components from other schemas on the network. You can view the content model of a component belonging to another schema and reuse this component with or without modifications. You can also build relationships between schemas, thereby enabling you to modularize and manage complex schemas directly from within XMLSpy.

See also the SchemaAgent Tutorial.

In order for XMLSpy to work as a SchemaAgent client, you must do the following:

- Download Altova's SchemaAgent 2012 product from the [SchemaAgent download page](#) at the Altova website and install it on the same machine as XMLSpy. SchemaAgent Client requires a license that must be purchased from Altova. The Altova® MissionKit™ 2012 products each include the SchemaAgent Client product and a license key for it. (The SchemaAgent Server application, however, is not included in the Altova® MissionKit™ 2012 packages.) You can get to work directly, using the LocalServer that is included in the SchemaAgent package and installed when you install SchemaAgent.
- Optionally download SchemaAgent Server from the [SchemaAgent download page](#) at the Altova website and install it anywhere on your network. SchemaAgent Server is available free of charge.
- [Define the search path\(s\)](#) for a SchemaAgent server (either LocalServer or SchemaAgent Server). A detailed description of how to do this is given earlier in this SchemaAgent documentation.
- Start a connection from within XMLSpy to a SchemaAgent server (either LocalServer or SchemaAgent Server).

A detailed description of how to use SchemaAgent functionality in XMLSpy is given in the XMLSpy documentation.

Chapter 8

License Information

8 License Information

This section contains:

- Information about the [distribution of this software product](#)
- Information about the [intellectual property rights](#) related to this software product
- The [End User License Agreement](#) governing the use of this software product

Please read this information carefully. It is binding upon you since you agreed to these terms when you installed this software product.

8.1 Electronic Software Distribution

This product is available through electronic software distribution, a distribution method that provides the following unique benefits:

- You can evaluate the software free-of-charge before making a purchasing decision.
- Once you decide to buy the software, you can place your order online at the [Altova website](#) and immediately get a fully licensed product within minutes.
- When you place an online order, you always get the latest version of our software.
- The product package includes a comprehensive integrated onscreen help system. The latest version of the user manual is available at www.altova.com (i) in HTML format for online browsing, and (ii) in PDF format for download (and to print if you prefer to have the documentation on paper).

30-day evaluation period

After downloading this product, you can evaluate it for a period of up to 30 days free of charge. About 20 days into this evaluation period, the software will start to remind you that it has not yet been licensed. The reminder message will be displayed once each time you start the application. If you would like to continue using the program after the 30-day evaluation period, you have to purchase an [Altova Software License Agreement](#), which is delivered in the form of a key-code that you enter into the Software Activation dialog to unlock the product. You can purchase your license at the online shop at the [Altova website](#).

Helping Others within Your Organization to Evaluate the Software

If you wish to distribute the evaluation version within your company network, or if you plan to use it on a PC that is not connected to the Internet, you may only distribute the Setup programs, provided that they are not modified in any way. Any person that accesses the software installer that you have provided, must request their own 30-day evaluation license key code and after expiration of their evaluation period, must also purchase a license in order to be able to continue using the product.

For further details, please refer to the [Altova Software License Agreement](#) at the end of this section.

8.2 Software Activation and License Metering

As part of Altova's Software Activation, the software may use your internal network and Internet connection for the purpose of transmitting license-related data at the time of installation, registration, use, or update to an Altova-operated license server and validating the authenticity of the license-related data in order to protect Altova against unlicensed or illegal use of the software and to improve customer service. Activation is based on the exchange of license related data such as operating system, IP address, date/time, software version, and computer name, along with other information between your computer and an Altova license server.

Your Altova product has a built-in license metering module that further helps you avoid any unintentional violation of the End User License Agreement. Your product is licensed either as a single-user or multi-user installation, and the license-metering module makes sure that no more than the licensed number of users use the application concurrently.

This license-metering technology uses your local area network (LAN) to communicate between instances of the application running on different computers.

Single license

When the application starts up, as part of the license metering process, the software sends a short broadcast datagram to find any other instance of the product running on another computer in the same network segment. If it doesn't get any response, it will open a port for listening to other instances of the application.

Multi license

If more than one instance of the application is used within the same LAN, these instances will briefly communicate with each other on startup. These instances exchange key-codes in order to help you to better determine that the number of concurrent licenses purchased is not accidentally violated. This is the same kind of license metering technology that is common in the Unix world and with a number of database development tools. It allows Altova customers to purchase reasonably-priced concurrent-use multi-user licenses.

We have also designed the applications so that they send few and small network packets so as to not put a burden on your network. The TCP/IP ports (2799) used by your Altova product are officially registered with the IANA (see [the IANA website \(http://www.iana.org/\)](http://www.iana.org/) for details) and our license-metering module is tested and proven technology.

If you are using a firewall, you may notice communications on port 2799 between the computers that are running Altova products. You are, of course, free to block such traffic between different groups in your organization, as long as you can ensure by other means, that your license agreement is not violated.

You will also notice that, if you are online, your Altova product contains many useful functions; these are unrelated to the license-metering technology.

8.3 Intellectual Property Rights

The Altova Software and any copies that you are authorized by Altova to make are the intellectual property of and are owned by Altova and its suppliers. The structure, organization and code of the Software are the valuable trade secrets and confidential information of Altova and its suppliers. The Software is protected by copyright, including without limitation by United States Copyright Law, international treaty provisions and applicable laws in the country in which it is being used. Altova retains the ownership of all patents, copyrights, trade secrets, trademarks and other intellectual property rights pertaining to the Software, and that Altova's ownership rights extend to any images, photographs, animations, videos, audio, music, text and "applets" incorporated into the Software and all accompanying printed materials. Notifications of claimed copyright infringement should be sent to Altova's copyright agent as further provided on the Altova Web Site.

Altova software contains certain Third Party Software that is also protected by intellectual property laws, including without limitation applicable copyright laws as described in detail at http://www.altova.com/legal_3rdparty.html.

All other names or trademarks are the property of their respective owners.

8.4 Altova End User License Agreement

THIS IS A LEGAL DOCUMENT -- RETAIN FOR YOUR RECORDS

ALTOVA® END USER LICENSE AGREEMENT

Licensor:
Altova GmbH
Rudolfsplatz 13a/9
A-1010 Wien
Austria

Important - Read Carefully. Notice to User:

This End User License Agreement (“Software License Agreement”) is a legal document between you and Altova GmbH (“Altova”). It is important that you read this document before using the Altova-provided software (“Software”) and any accompanying documentation, including, without limitation printed materials, ‘online’ files, or electronic documentation (“Documentation”). By clicking the “I accept” and “Next” buttons below, or by installing, or otherwise using the Software, you agree to be bound by the terms of this Software License Agreement as well as the Altova Privacy Policy (“Privacy Policy”) including, without limitation, the warranty disclaimers, limitation of liability, data use and termination provisions below, whether or not you decide to purchase the Software. You agree that this agreement is enforceable like any written agreement negotiated and signed by you. If you do not agree, you are not licensed to use the Software, and you must destroy any downloaded copies of the Software in your possession or control. You may print a copy of this Software License Agreement as part of the installation process at the time of acceptance. Alternatively, you may go to our Web site at <http://www.altova.com/eula> to download and print a copy of this Software License Agreement for your files and <http://www.altova.com/privacy> to review the Privacy Policy.

1. SOFTWARE LICENSE

(a) License Grant.

(i) Upon your acceptance of this Software License Agreement Altova grants you a non-exclusive, non-transferable (except as provided below), limited license, without the right to grant sublicenses, to install and use a copy of the Software on one compatible personal computer or workstation up to the Permitted Number of computers. Subject to the limitations set forth in Section 1(c), you may install and use a copy of the Software on more than one of your compatible personal computers or workstations if you have purchased a Named-User license. Subject to the limitations set forth in Sections 1(d) and 1(e), users may use the software concurrently on a network. The Permitted Number of computers and/or users and the type of license, e.g. Installed, Named-Users, and Concurrent-User, shall be determined and specified at such time as you elect to purchase the Software. Installed user licenses are intended to be fixed and not concurrent. In other words, you cannot uninstall for one user in order to reinstall that license to a different user and then uninstall and reinstall back to the original user. Users should be static. Notwithstanding the foregoing, permanent switchovers are acceptable (i.e., an employee has left the company, machine is retired). During the evaluation period, hereinafter defined, only a single user may install and use the software on one (1) personal computer or workstation. If you have licensed the Software as part of a suite of Altova software products (collectively, the “Suite”) and have not installed each product individually, then the Software License Agreement governs your use of all of the software included in the Suite.

(ii) If you have licensed SchemaAgent, then the terms and conditions of this Software License Agreement apply to your use of the SchemaAgent server software (“SchemaAgent Server”) included therein, as applicable, and you are licensed to use

SchemaAgent Server solely in connection with your use of Altova Software and solely for the purposes described in the accompanying documentation.

(iii) If you have licensed Software that enables users to generate source code, your license to install and use a copy of the Software as provided herein permits you to generate source code based on (i) Altova Library modules that are included in the Software (such generated code hereinafter referred to as the “Restricted Source Code”) and (ii) schemas or mappings that you create or provide (such code as may be generated from your schema or mapping source materials hereinafter referred to as the “Unrestricted Source Code”). In addition to the rights granted herein, Altova grants you a non-exclusive, non-transferable, limited license to compile the complete generated code (comprised of the combination of the Restricted Source Code and the Unrestricted Source Code) into executable object code form, and to use, copy, distribute or license that executable. You may not distribute or redistribute, sublicense, sell, or transfer the Restricted Source Code to a third-party unless said third-party already has a license to the Restricted Source Code through their separate agreement with Altova. Notwithstanding anything to the contrary herein, you may not distribute, incorporate or combine with other software, or otherwise use the Altova Library modules or Restricted Source Code, or any Altova intellectual property embodied in or associated with the Altova Library modules or Restricted Source Code, in any manner that would subject the Restricted Source Code to the terms of a copyleft, free software or open source license that would require the Restricted Source Code or Altova Library modules source code to be disclosed in source code form. Altova reserves all other rights in and to the Software. With respect to the feature(s) of UModel that permit reverse-engineering of your own source code or other source code that you have lawfully obtained, such use by you does not constitute a violation of this Agreement. Except as otherwise expressly permitted in Section 1(i) reverse engineering of the Software is strictly prohibited as further detailed therein.

(iv) In the event Restricted Source Code is incorporated into executable object code form, you will include the following statement in (1) introductory splash screens, or if none, within one or more screens readily accessible by the end-user, and (2) in the electronic and/or hard copy documentation: “Portions of this program were developed using Altova® ~~xname of~~ Altova Software, e.g. MapForce® 2011z and include libraries owned by Altova GmbH, Copyright © 2007-2011 Altova GmbH (www.altova.com).”

(b) Server Use for Installation and Use of SchemaAgent. You may install one (1) copy of the Software on a computer file server within your internal network solely for the purpose of downloading and installing the Software onto other computers within your internal network up to the Permitted Number of computers in a commercial environment only. If you have licensed SchemaAgent, then you may install SchemaAgent Server on any server computer or workstation and use it in connection with your Software. No other network use is permitted, including without limitation using the Software either directly or through commands, data or instructions from or to a computer not part of your internal network, for Internet or Web-hosting services or by any user not licensed to use this copy of the Software through a valid license from Altova.

(c) Named-Use. If you have licensed the “Named-User” version of the software, you may install the Software on up to five (5) compatible personal computers or workstations of which you are the primary user thereby allowing you to switch from one computer to the other as necessary provided that only one (1) instance of the Software will be used by you as the Named-User at any given time. If you have purchased multiple Named-User licenses, each individual Named-User will receive a separate license key code.

(d) Concurrent Use in Same Physical Network or Office Location. If you have licensed a “Concurrent-User” version of the Software, you may install the Software on any compatible computers in a commercial environment only, up to ten (10) times the Permitted Number of users, provided that only the Permitted Number of users actually use the Software at the same time and further provided that the computers on which the Software is installed are on the same

physical computer network. The Permitted Number of concurrent users shall be delineated at such time as you elect to purchase the Software licenses. Each separate physical network or office location requires its own set of separate Concurrent User Licenses for those wishing to use the Concurrent User versions of the Software in more than one location or on more than one network, all subject to the above Permitted Number limitations and based on the number of users using the Software. If a computer is not on the same physical network, then a locally installed user license or a license dedicated to concurrent use in a virtual environment is required. Home User restrictions and limitations with respect to the Concurrent User licenses used on home computers are set forth in Section 1(g).

(e) Concurrent Use in Virtual Environment. If you have purchased Concurrent-User Licenses, you may install a copy of the Software on a terminal server (Microsoft Terminal Server, Citrix Metaframe, etc.), application virtualization server (Microsoft App-V, Citrix XenApp, VMWare ThinApp, etc.) or virtual machine environment within your internal network for the sole and exclusive purpose of permitting individual users within your organization to access and use the Software through a terminal server, application virtualization session, or virtual machine environment from another computer provided that the total number of users that access or use the Software concurrently at any given point in time on such network, virtual machine or terminal server does not exceed the Permitted Number; and provided that the total number of users authorized to use the Software through the terminal server, application virtualization session, or virtual machine environment does not exceed six (6) times the Permitted Number of users. Accordingly, the limitations set forth in Section 1(d) regarding the number of installations and the requirement that the usage be on the same physical network shall not apply to terminal server, application virtualization session, or virtual machine environments. In a virtual environment, you must deploy a means of preventing users from exceeding the Permitted Number of concurrent users. Altova makes no warranties or representations about the performance of Altova software in a terminal server, application virtualization session, or virtual machine environment and the foregoing are expressly excluded from the limited warranty in Section 5 hereof and technical support is not available with respect to issues arising from use in such environments.

(f) Backup and Archival Copies. You may make one (1) backup and one (1) archival copy of the Software, provided your backup and archival copies are not installed or used on any computer and further provided that all such copies shall bear the original and unmodified copyright, patent and other intellectual property markings that appear on or in the Software. You may not transfer the rights to a backup or archival copy unless you transfer all rights in the Software as provided under Section 3.

(g) Home Use (Personal and Non-Commercial). In order to further familiarize yourself with the Software and allow you to explore its features and functions, you, as the primary user of the computer on which the Software is installed for commercial purposes, may also install one copy of the Software on only one (1) home personal computer (such as your laptop or desktop) solely for your personal and non-commercial ("HPNC") use. This HPNC copy may not be used in any commercial or revenue-generating business activities, including without limitation, work-from-home, teleworking, telecommuting, or other work-related use of the Software. The HPNC copy of the Software may not be used at the same time on a home personal computer as the Software is being used on the primary computer.

(h) Key Codes, Upgrades and Updates. Prior to your purchase and as part of the registration for the thirty (30) day evaluation period, as applicable, you will receive an evaluation key code. You will receive a purchase key code when you elect to purchase the Software from either Altova GmbH or an authorized reseller. The purchase key code will enable you to activate the Software beyond the initial evaluation period. You may not re-license, reproduce or distribute any key code except with the express written permission of Altova. If the Software that you have licensed is an upgrade or an update, then the latest update or upgrade that you download and install replaces all or part of the Software previously licensed. The update or upgrade and the associated license keys does not constitute the granting of a second license to

the Software in that you may not use the upgrade or updated copy in addition to the copy of the Software that it is replacing and whose license has terminated.

(i) Title. Title to the Software is not transferred to you. Ownership of all copies of the Software and of copies made by you is vested in Altova, subject to the rights of use granted to you in this Software License Agreement. As between you and Altova, documents, files, stylesheets, generated program code (including the Unrestricted Source Code) and schemas that are authored or created by you via your utilization of the Software, in accordance with its Documentation and the terms of this Software License Agreement, are your property unless they are created using Evaluation Software, as defined in Section 4 of this Agreement, in which case you have only a limited license to use any output that contains generated program code (including Unrestricted Source Code) such as Java, C++, C#, VB.NET or XSLT and associated project files and build scripts, as well as generated XML, XML Schemas, documentation, UML diagrams, and database structures only for the thirty (30) day evaluation period.

(j) Reverse Engineering. Except and to the limited extent as may be otherwise specifically provided by applicable law in the European Union, you may not reverse engineer, decompile, disassemble or otherwise attempt to discover the source code, underlying ideas, underlying user interface techniques or algorithms of the Software by any means whatsoever, directly or indirectly, or disclose any of the foregoing, except to the extent you may be expressly permitted to decompile under applicable law in the European Union, if it is essential to do so in order to achieve operability of the Software with another software program, and you have first requested Altova to provide the information necessary to achieve such operability and Altova has not made such information available. Altova has the right to impose reasonable conditions and to request a reasonable fee before providing such information. Any information supplied by Altova or obtained by you, as permitted hereunder, may only be used by you for the purpose described herein and may not be disclosed to any third party or used to create any software which is substantially similar to the expression of the Software. Requests for information from users in the European Union with respect to the above should be directed to the Altova Customer Support Department.

(k) Other Restrictions. You may not loan, rent, lease, sublicense, distribute or otherwise transfer all or any portion of the Software to third parties except to the limited extent set forth in Section 3 or as otherwise expressly provided. You may not copy the Software except as expressly set forth above, and any copies that you are permitted to make pursuant to this Software License Agreement must contain the same copyright, patent and other intellectual property markings that appear on or in the Software. You may not modify, adapt or translate the Software. You may not, directly or indirectly, encumber or suffer to exist any lien or security interest on the Software; knowingly take any action that would cause the Software to be placed in the public domain; or use the Software in any computer environment not specified in this Software License Agreement.

You will comply with applicable law and Altova's instructions regarding the use of the Software. You agree to notify your employees and agents who may have access to the Software of the restrictions contained in this Software License Agreement and to ensure their compliance with these restrictions.

(l) THE SOFTWARE IS NEITHER GUARANTEED NOR WARRANTED TO BE ERROR-FREE NOR SHALL ANY LIABILITY BE ASSUMED BY ALTOVA IN THIS RESPECT. NOTWITHSTANDING ANY SUPPORT FOR ANY TECHNICAL STANDARD, THE SOFTWARE IS NOT INTENDED FOR USE IN OR IN CONNECTION WITH, WITHOUT LIMITATION, THE OPERATION OF NUCLEAR FACILITIES, AIRCRAFT NAVIGATION, COMMUNICATION SYSTEMS, AIR TRAFFIC CONTROL EQUIPMENT, MEDICAL DEVICES OR LIFE SUPPORT SYSTEMS, MEDICAL OR HEALTH CARE APPLICATIONS, OR OTHER APPLICATIONS WHERE THE FAILURE OF THE SOFTWARE OR ERRORS IN DATA PROCESSING COULD LEAD TO DEATH, PERSONAL INJURY OR SEVERE PHYSICAL OR ENVIRONMENTAL DAMAGE. YOU AGREE THAT YOU ARE SOLELY RESPONSIBLE FOR

THE ACCURACY AND ADEQUACY OF THE SOFTWARE AND ANY DATA GENERATED OR PROCESSED BY THE SOFTWARE FOR YOUR INTENDED USE AND YOU WILL DEFEND, INDEMNIFY AND HOLD ALTOVA, ITS OFFICERS AND EMPLOYEES HARMLESS FROM ANY 3RD PARTY CLAIMS, DEMANDS, OR SUITS THAT ARE BASED UPON THE ACCURACY AND ADEQUACY OF THE SOFTWARE IN YOUR USE OR ANY DATA GENERATED BY THE SOFTWARE IN YOUR USE.

2. INTELLECTUAL PROPERTY RIGHTS

Acknowledgement of Altova's Rights. You acknowledge that the Software and any copies that you are authorized by Altova to make are the intellectual property of and are owned by Altova and its suppliers. The structure, organization and code of the Software are the valuable trade secrets and confidential information of Altova and its suppliers. The Software is protected by copyright, including without limitation by United States Copyright Law, international treaty provisions and applicable laws in the country in which it is being used. You acknowledge that Altova retains the ownership of all patents, copyrights, trade secrets, trademarks and other intellectual property rights pertaining to the Software, and that Altova's ownership rights extend to any images, photographs, animations, videos, audio, music, text and "applets" incorporated into the Software and all accompanying printed materials. You will take no actions which adversely affect Altova's intellectual property rights in the Software. Trademarks shall be used in accordance with accepted trademark practice, including identification of trademark owners' names. Trademarks may only be used to identify printed output produced by the Software, and such use of any trademark does not give you any right of ownership in that trademark. XMLSpy®, Authentic®, StyleVision®, MapForce®, UModel®, DatabaseSpy®, DiffDog®, SchemaAgent®, SemanticWorks®, MissionKit®, Markup Your Mind®, Nanonull™, and Altova® are trademarks of Altova GmbH. (registered in numerous countries). Unicode and the Unicode Logo are trademarks of Unicode, Inc. Windows, Windows XP, Windows Vista, and Windows 7 are trademarks of Microsoft. W3C, CSS, DOM, MathML, RDF, XHTML, XML and XSL are trademarks (registered in numerous countries) of the World Wide Web Consortium (W3C); marks of the W3C are registered and held by its host institutions, MIT, INRIA and Keio. Except as expressly stated above, this Software License Agreement does not grant you any intellectual property rights in the Software. Notifications of claimed copyright infringement should be sent to Altova's copyright agent as further provided on the Altova Web Site.

3. LIMITED TRANSFER RIGHTS

Notwithstanding the foregoing, you may transfer all your rights to use the Software to another person or legal entity provided that: (a) you also transfer each of this Software License Agreement, the Software and all other software or hardware bundled or pre-installed with the Software, including all copies, updates and prior versions, and all copies of font software converted into other formats, to such person or entity; (b) you retain no copies, including backups and copies stored on a computer; (c) the receiving party secures a personalized key code from Altova; and (d) the receiving party accepts the terms and conditions of this Software License Agreement and any other terms and conditions upon which you legally purchased a license to the Software. Notwithstanding the foregoing, you may not transfer education, pre-release, or not-for-resale copies of the Software.

4. PRE-RELEASE AND EVALUATION PRODUCT ADDITIONAL TERMS

If the product you have received with this license is pre-commercial release or beta Software ("Pre-release Software"), then this Section applies. In addition, this section applies to all evaluation and/or demonstration copies of Altova software ("Evaluation Software") and continues in effect until you purchase a license. To the extent that any provision in this section is in conflict with any other term or condition in this Software License Agreement, this section shall supersede such other term(s) and condition(s) with respect to the Pre-release and/or Evaluation Software, but only to the extent necessary to resolve the conflict. You acknowledge that the Pre-release Software is a pre-release version, does not represent final product from Altova, and

may contain bugs, errors and other problems that could cause system or other failures and data loss. CONSEQUENTLY, THE PRE-RELEASE AND/OR EVALUATION SOFTWARE IS PROVIDED TO YOU **“AS-IS” WITH NO WARRANTIES FOR USE OR PERFORMANCE**, AND ALTOVA DISCLAIMS ANY WARRANTY OR LIABILITY OBLIGATIONS TO YOU OF ANY KIND, WHETHER EXPRESS OR IMPLIED. WHERE LEGALLY LIABILITY CANNOT BE EXCLUDED FOR PRE-RELEASE AND/OR EVALUATION SOFTWARE, BUT IT MAY BE LIMITED, ALTOVA'S LIABILITY AND THAT OF ITS SUPPLIERS SHALL BE LIMITED TO THE SUM OF FIFTY DOLLARS (USD \$50) IN TOTAL. If the Evaluation Software has a time-out feature, then the software will cease operation after the conclusion of the designated evaluation period. Upon such expiration date, your license will expire unless otherwise extended. Your license to use any output created with the Evaluation Software that contains generated program code (including Unrestricted Source Code) such as Java, C++, C, VB.NET or XSLT and associated project files and build scripts as well as generated XML, XML Schemas, documentation, UML diagrams, and database structures terminates automatically upon the expiration of the designated evaluation period but the license to use such output is revived upon your purchase of a license for the Software that you evaluated and used to create such output. Access to any files created with the Evaluation Software is entirely at your risk. You acknowledge that Altova has not promised or guaranteed to you that Pre-release Software will be announced or made available to anyone in the future, that Altova has no express or implied obligation to you to announce or introduce the Pre-release Software, and that Altova may not introduce a product similar to or compatible with the Pre-release Software. Accordingly, you acknowledge that any research or development that you perform regarding the Pre-release Software or any product associated with the Pre-release Software is done entirely at your own risk. During the term of this Software License Agreement, if requested by Altova, you will provide feedback to Altova regarding testing and use of the Pre-release Software, including error or bug reports. If you have been provided the Pre-release Software pursuant to a separate written agreement, your use of the Software is governed by such agreement. You may not sublicense, lease, loan, rent, distribute or otherwise transfer the Pre-release Software. Upon receipt of a later unreleased version of the Pre-release Software or release by Altova of a publicly released commercial version of the Software, whether as a stand-alone product or as part of a larger product, you agree to return or destroy all earlier Pre-release Software received from Altova and to abide by the terms of the license agreement for any such later versions of the Pre-release Software.

5. LIMITED WARRANTY AND LIMITATION OF LIABILITY

(a) Limited Warranty and Customer Remedies. Altova warrants to the person or entity that first purchases a license for use of the Software pursuant to the terms of this Software License Agreement that (i) the Software will perform substantially in accordance with any accompanying Documentation for a period of ninety (90) days from the date of receipt, and (ii) any support services provided by Altova shall be substantially as described in Section 6 of this agreement. Some states and jurisdictions do not allow limitations on duration of an implied warranty, so the above limitation may not apply to you. To the extent allowed by applicable law, implied warranties on the Software, if any, are limited to ninety (90) days. Altova's and its suppliers' entire liability and your exclusive remedy shall be, at Altova's option, either (i) return of the price paid, if any, or (ii) repair or replacement of the Software that does not meet Altova's Limited Warranty and which is returned to Altova with a copy of your receipt. This Limited Warranty is void if failure of the Software has resulted from accident, abuse, misapplication, abnormal use, Trojan horse, virus, or any other malicious external code. Any replacement Software will be warranted for the remainder of the original warranty period or thirty (30) days, whichever is longer. This limited warranty does not apply to Evaluation and/or Pre-release Software.

(b) No Other Warranties and Disclaimer. THE FOREGOING LIMITED WARRANTY AND REMEDIES STATE THE SOLE AND EXCLUSIVE REMEDIES FOR ALTOVA OR ITS SUPPLIER'S BREACH OF WARRANTY. ALTOVA AND ITS SUPPLIERS DO NOT AND CANNOT WARRANT THE PERFORMANCE OR RESULTS YOU MAY OBTAIN BY USING

THE SOFTWARE. EXCEPT FOR THE FOREGOING LIMITED WARRANTY, AND FOR ANY WARRANTY, CONDITION, REPRESENTATION OR TERM TO THE EXTENT WHICH THE SAME CANNOT OR MAY NOT BE EXCLUDED OR LIMITED BY LAW APPLICABLE TO YOU IN YOUR JURISDICTION, ALTOVA AND ITS SUPPLIERS MAKE NO WARRANTIES, CONDITIONS, REPRESENTATIONS OR TERMS, EXPRESS OR IMPLIED, WHETHER BY STATUTE, COMMON LAW, CUSTOM, USAGE OR OTHERWISE AS TO ANY OTHER MATTERS. TO THE MAXIMUM EXTENT PERMITTED BY APPLICABLE LAW, ALTOVA AND ITS SUPPLIERS DISCLAIM ALL OTHER WARRANTIES AND CONDITIONS, EITHER EXPRESS OR IMPLIED, INCLUDING, BUT NOT LIMITED TO, IMPLIED WARRANTIES OF MERCHANTABILITY, FITNESS FOR A PARTICULAR PURPOSE, SATISFACTORY QUALITY, INFORMATIONAL CONTENT OR ACCURACY, QUIET ENJOYMENT, TITLE AND NON-INFRINGEMENT, WITH REGARD TO THE SOFTWARE, AND THE PROVISION OF OR FAILURE TO PROVIDE SUPPORT SERVICES. THIS LIMITED WARRANTY GIVES YOU SPECIFIC LEGAL RIGHTS. YOU MAY HAVE OTHERS, WHICH VARY FROM STATE/JURISDICTION TO STATE/JURISDICTION.

(c) Limitation of Liability. TO THE MAXIMUM EXTENT PERMITTED BY APPLICABLE LAW EVEN IF A REMEDY FAILS ITS ESSENTIAL PURPOSE, IN NO EVENT SHALL ALTOVA OR ITS SUPPLIERS BE LIABLE FOR ANY SPECIAL, INCIDENTAL, DIRECT, INDIRECT OR CONSEQUENTIAL DAMAGES WHATSOEVER (INCLUDING, WITHOUT LIMITATION, DAMAGES FOR LOSS OF BUSINESS PROFITS, BUSINESS INTERRUPTION, LOSS OF BUSINESS INFORMATION, OR ANY OTHER PECUNIARY LOSS) ARISING OUT OF THE USE OF OR INABILITY TO USE THE SOFTWARE OR THE PROVISION OF OR FAILURE TO PROVIDE SUPPORT SERVICES, EVEN IF ALTOVA HAS BEEN ADVISED OF THE POSSIBILITY OF SUCH DAMAGES. IN ANY CASE, ALTOVA'S ENTIRE LIABILITY UNDER ANY PROVISION OF THIS SOFTWARE LICENSE AGREEMENT SHALL BE LIMITED TO THE AMOUNT ACTUALLY PAID BY YOU FOR THE SOFTWARE PRODUCT. Because some states and jurisdictions do not allow the exclusion or limitation of liability, the above limitation may not apply to you. In such states and jurisdictions, Altova's liability shall be limited to the greatest extent permitted by law and the limitations or exclusions of warranties and liability contained herein do not prejudice applicable statutory consumer rights of person acquiring goods otherwise than in the course of business. The disclaimer and limited liability above are fundamental to this Software License Agreement between Altova and you.

(d) Infringement Claims. Altova will indemnify and hold you harmless and will defend or settle any claim, suit or proceeding brought against you by a third party that is based upon a claim that the content contained in the Software infringes a copyright or violates an intellectual or proprietary right protected by United States or European Union law ("Claim"), but only to the extent the Claim arises directly out of the use of the Software and subject to the limitations set forth in Section 5 of this Agreement except as otherwise expressly provided. You must notify Altova in writing of any Claim within ten (10) business days after you first receive notice of the Claim, and you shall provide to Altova at no cost such assistance and cooperation as Altova may reasonably request from time to time in connection with the defense of the Claim. Altova shall have sole control over any Claim (including, without limitation, the selection of counsel and the right to settle on your behalf on any terms Altova deems desirable in the sole exercise of its discretion). You may, at your sole cost, retain separate counsel and participate in the defense or settlement negotiations. Altova shall pay actual damages, costs, and attorney fees awarded against you (or payable by you pursuant to a settlement agreement) in connection with a Claim to the extent such direct damages and costs are not reimbursed to you by insurance or a third party, to an aggregate maximum equal to the purchase price of the Software. If the Software or its use becomes the subject of a Claim or its use is enjoined, or if in the opinion of Altova's legal counsel the Software is likely to become the subject of a Claim, Altova shall attempt to resolve the Claim by using commercially reasonable efforts to modify the Software or obtain a license to continue using the Software. If in the opinion of Altova's legal counsel the Claim, the injunction or potential Claim cannot be resolved through reasonable modification or licensing, Altova, at its own election, may terminate this Software License Agreement without penalty, and will refund to you on a pro rata basis any fees paid in advance by you to Altova. THE FOREGOING

CONSTITUTES ALTOVA'S SOLE AND EXCLUSIVE LIABILITY FOR INTELLECTUAL PROPERTY INFRINGEMENT. This indemnity does not apply to infringements that would not be such, except for customer-supplied elements.

6. SUPPORT AND MAINTENANCE

Altova offers multiple optional "Support & Maintenance Package(s)" ("SMP") for the version of Software product edition that you have licensed, which you may elect to purchase in addition to your Software license. The Support Period, hereinafter defined, covered by such SMP shall be delineated at such time as you elect to purchase a SMP. Your rights with respect to support and maintenance as well as your upgrade eligibility depend on your decision to purchase SMP and the level of SMP that you have purchased:

(a) If you have not purchased SMP, you will receive the Software AS IS and will not receive any maintenance releases or updates. However, Altova, at its option and in its sole discretion on a case by case basis, may decide to offer maintenance releases to you as a courtesy, but these maintenance releases will not include any new features in excess of the feature set at the time of your purchase of the Software. In addition, Altova will provide free technical support to you for thirty (30) days after the date of your purchase (the "Support Period" for the purposes of this paragraph 6(a), and Altova, in its sole discretion on a case by case basis, may also provide free courtesy technical support during your thirty (30) day evaluation period. Technical support is provided via a Web-based support form only, and there is no guaranteed response time.

(b) If you have purchased SMP, then solely for the duration of its delineated Support Period, **you are eligible to receive the version of the Software edition** that you have licensed and all maintenance releases and updates for that edition that are released during your Support Period. For the duration of your SMP's Support Period, you will also be eligible to receive upgrades to the comparable edition of the next version of the Software that succeeds the Software edition that you have licensed for applicable upgrades released during your Support Period. The specific upgrade edition that you are eligible to receive based on your Support Period is further detailed in the SMP that you have purchased. Software that is introduced as separate product is not included in SMP. Maintenance releases, updates and upgrades may or may not include additional features. In addition, Altova will provide Priority Technical Support to you for the duration of the Support Period. Priority Technical Support is provided via a Web-based support form only and Altova will make commercially reasonable efforts to respond via e-mail to all requests within forty-eight (48) hours during Altova's business hours (MO-FR, 8am UTC – 10pm UTC, Austrian and US holidays excluded) and to make reasonable efforts to provide work-arounds to errors reported in the Software.

During the Support Period you may also report any Software problem or error to Altova. If Altova determines that a reported reproducible material error in the Software exists and significantly impairs the usability and utility of the Software, Altova agrees to use reasonable commercial efforts to correct or provide a usable work-around solution in an upcoming maintenance release or update, which is made available at certain times at Altova's sole discretion.

If Altova, in its discretion, requests written verification of an error or malfunction discovered by you or requests supporting example files that exhibit the Software problem, you shall promptly provide such verification or files, by email, telecopy, or overnight mail, setting forth in reasonable detail the respects in which the Software fails to perform. You shall use reasonable efforts to cooperate in diagnosis or study of errors. Altova may include error corrections in maintenance releases, updates, or new major releases of the Software. Altova is not obligated to fix errors that are immaterial. Immaterial errors are those that do not significantly impact use of the Software as determined by Altova in its sole discretion. Whether or not you have purchased the Support & Maintenance Package, technical support only covers issues or questions resulting directly out of the operation of the Software and Altova will not provide you with generic consultation, assistance, or advice under any circumstances.

Updating Software may require the updating of software not covered by this Software License Agreement before installation. Updates of the operating system and application software not specifically covered by this Software License Agreement are your responsibility and will not be provided by Altova under this Software License Agreement. Altova's obligations under this Section 6 are contingent upon your proper use of the Software and your compliance with the terms and conditions of this Software License Agreement at all times. Altova shall be under no obligation to provide the above technical support if, in Altova's opinion, the Software has failed due to the following conditions: (i) damage caused by the relocation of the software to another location or CPU; (ii) alterations, modifications or attempts to change the Software without Altova's written approval; (iii) causes external to the Software, such as natural disasters, the failure or fluctuation of electrical power, or computer equipment failure; (iv) your failure to maintain the Software at Altova's specified release level; or (v) use of the Software with other software without Altova's prior written approval. It will be your sole responsibility to: (i) comply with all Altova-specified operating and troubleshooting procedures and then notify Altova immediately of Software malfunction and provide Altova with complete information thereof; (ii) provide for the security of your confidential information; (iii) establish and maintain backup systems and procedures necessary to reconstruct lost or altered files, data or programs.

7. SOFTWARE ACTIVATION, UPDATES AND LICENSE METERING

(a) **License Metering.** Altova has a built-in license metering module that helps you to avoid any unintentional violation of this Software License Agreement. Altova may use your internal network for license metering between installed versions of the Software.

(b) **Software Activation.** Altova's Software may use your internal network and Internet connection for the purpose of transmitting license-related data at the time of installation, registration, use, or update to an Altova-operated license server and validating the authenticity of the license-related data in order to protect Altova against unlicensed or illegal use of the Software and to improve customer service. Activation is based on the exchange of license related data between your computer and the Altova license server. You agree that Altova may use these measures and you agree to follow any applicable requirements. You further agree that use of license key codes that are not or were not generated by Altova and lawfully obtained from Altova, or an authorized reseller as part of an effort to activate or use the Software violates Altova's intellectual property rights as well as the terms of this Software License Agreement. You agree that efforts to circumvent or disable Altova's copyright protection mechanisms or license management mechanism violate Altova's intellectual property rights as well as the terms of this Software License Agreement. Altova expressly reserves the rights to seek all available legal and equitable remedies to prevent such actions and to recover lost profits, damages and costs.

(c) **LiveUpdate.** Altova provides a new LiveUpdate notification service to you, which is free of charge. Altova may use your internal network and Internet connection for the purpose of transmitting license-related data to an Altova-operated LiveUpdate server to validate your license at appropriate intervals and determine if there is any update available for you.

(d) **Use of Data.** The terms and conditions of the Privacy Policy are set out in full at <http://www.altova.com/privacy> and are incorporated by reference into this Software License Agreement. By your acceptance of the terms of this Software License Agreement and/or use of the Software, you authorize the collection, use and disclosure of information collected by Altova for the purposes provided for in this Software License Agreement and/or the Privacy Policy. Altova has the right in its sole discretion to amend this provision of the Software License Agreement and/or Privacy Policy at any time. You are encouraged to review the terms of the Privacy Policy as posted on the Altova Web site from time to time.

(e) **Notice to European Users.** Please note that the information as described in paragraph 7(d) above may be transferred outside of the European Economic Area, for purposes

of processing, analysis, and review, by Altova, Inc., a company located in Beverly, Massachusetts, U.S.A., or its subsidiaries or Altova's subsidiaries or divisions, or authorized partners, located worldwide. You are advised that the United States uses a sectoral model of privacy protection that relies on a mix of legislation, governmental regulation, and self-regulation. You are further advised that the Council of the European Union has found that this model does not provide "adequate" privacy protections as contemplated by Article 25 of the European Union's Data Directive. (Directive 95/46/EC, 1995 O.J. (L 281) 31). Article 26 of the European Union's Data Directive allows for transfer of personal data from the European Union to a third country if the individual has unambiguously given his consent to the transfer of personal information, regardless of the third country's level of protection. By agreeing to this Software License Agreement, you consent to the transfer of all such information to the United States and the processing of that information as described in this Software License Agreement and the Privacy Policy.

8. TERM AND TERMINATION

This Software License Agreement may be terminated (a) by your giving Altova written notice of termination; (b) by Altova, at its option, giving you written notice of termination if you commit a breach of this Software License Agreement and fail to cure such breach within ten (10) days after notice from Altova; or (c) at the request of an authorized Altova reseller in the event that you fail to make your license payment or other monies due and payable. In addition the Software License Agreement governing your use of a previous version that you have upgraded or updated of the Software is terminated upon your acceptance of the terms and conditions of the Software License Agreement accompanying such upgrade or update. Upon any termination of the Software License Agreement, you must cease all use of the Software that this Software License Agreement governs, destroy all copies then in your possession or control and take such other actions as Altova may reasonably request to ensure that no copies of the Software remain in your possession or control. The terms and conditions set forth in Sections 1(h), 1(i), 1(j), 1(k), 2, 5(b), 5(c), 5(d), 7(d), 7(e), 9, 10 and 11 survive termination as applicable.

9. RESTRICTED RIGHTS NOTICE AND EXPORT RESTRICTIONS

The Software was developed entirely at private expense and is commercial computer software provided with **RESTRICTED RIGHTS**. Use, duplication or disclosure by the U.S. Government or a U.S. Government contractor or subcontractor is subject to the restrictions set forth in this Agreement and as provided in FAR 12.211 and 12.212 (48 C.F.R. §12.211 and 12.212) or DFARS 227. 7202 (48 C.F.R. §227-7202) as applicable. Consistent with the above as applicable, Commercial Computer Software and Commercial Computer Documentation licensed to U.S. government end users only as commercial items and only with those rights as are granted to all other end users under the terms and conditions set forth in this Software License Agreement. Manufacturer is Altova GmbH, Rudolfspatz, 13a/9, A-1010 Vienna, Austria/EU. You may not use or otherwise export or re-export the Software or Documentation except as authorized by United States law and the laws of the jurisdiction in which the Software was obtained. In particular, but without limitation, the Software or Documentation may not be exported or re-exported (i) into (or to a national or resident of) any U.S. embargoed country or (ii) to anyone on the U.S. Treasury Department's list of Specially Designated Nationals or the U.S. Department of Commerce's Table of Denial Orders. By using the Software, you represent and warrant that you are not located in, under control of, or a national or resident of any such country or on any such list.

10. THIRD PARTY SOFTWARE

The Software may contain third party software which requires notices and/or additional terms and conditions. Such required third party software notices and/or additional terms and conditions are located at our Website at http://www.altova.com/legal_3rdparty.html and are made a part of and incorporated by reference into this Agreement. By accepting this Agreement, you are also accepting the additional terms and conditions, if any, set forth therein.

11. GENERAL PROVISIONS

If you are located in the European Union and are using the Software in the European Union and not in the United States, then this Software License Agreement will be governed by and construed in accordance with the laws of the Republic of Austria (excluding its conflict of laws principles and the U.N. Convention on Contracts for the International Sale of Goods) and you expressly agree that exclusive jurisdiction for any claim or dispute with Altova or relating in any way to your use of the Software resides in the Handelsgericht, Wien (Commercial Court, Vienna) and you further agree and expressly consent to the exercise of personal jurisdiction in the Handelsgericht, Wien (Commercial Court, Vienna) in connection with any such dispute or claim.

If you are located in the United States or are using the Software in the United States then this Software License Agreement will be governed by and construed in accordance with the laws of the Commonwealth of Massachusetts, USA (excluding its conflict of laws principles and the U.N. Convention on Contracts for the International Sale of Goods) and you expressly agree that exclusive jurisdiction for any claim or dispute with Altova or relating in any way to your use of the Software resides in the federal or state courts of the Commonwealth of Massachusetts and you further agree and expressly consent to the exercise of personal jurisdiction in the federal or state courts of the Commonwealth of Massachusetts in connection with any such dispute or claim.

If you are located outside of the European Union or the United States and are not using the Software in the United States, then this Software License Agreement will be governed by and construed in accordance with the laws of the Republic of Austria (excluding its conflict of laws principles and the U.N. Convention on Contracts for the International Sale of Goods) and you expressly agree that exclusive jurisdiction for any claim or dispute with Altova or relating in any way to your use of the Software resides in the Handelsgericht, Wien (Commercial Court, Vienna) and you further agree and expressly consent to the exercise of personal jurisdiction in the Handelsgericht Wien (Commercial Court, Vienna) in connection with any such dispute or claim. This Software License Agreement will not be governed by the conflict of law rules of any jurisdiction or the United Nations Convention on Contracts for the International Sale of Goods, the application of which is expressly excluded.

This Software License Agreement contains the entire agreement and understanding of the parties with respect to the subject matter hereof, and supersedes all prior written and oral understandings of the parties with respect to the subject matter hereof. Any notice or other communication given under this Software License Agreement shall be in writing and shall have been properly given by either of us to the other if sent by certified or registered mail, return receipt requested, or by overnight courier to the address shown on Altova's Web site for Altova and the address shown in Altova's records for you, or such other address as the parties may designate by notice given in the manner set forth above. This Software License Agreement will bind and inure to the benefit of the parties and our respective heirs, personal and legal representatives, affiliates, successors and permitted assigns. The failure of either of us at any time to require performance of any provision hereof shall in no manner affect such party's right at a later time to enforce the same or any other term of this Software License Agreement. This Software License Agreement may be amended only by a document in writing signed by both of us. In the event of a breach or threatened breach of this Software License Agreement by either party, the other shall have all applicable equitable as well as legal remedies. Each party is duly authorized and empowered to enter into and perform this Software License Agreement. If, for any reason, any provision of this Software License Agreement is held invalid or otherwise unenforceable, such invalidity or unenforceability shall not affect the remainder of this Software License Agreement, and this Software License Agreement shall continue in full force and effect to the fullest extent allowed by law. The parties knowingly and expressly consent to the foregoing terms and conditions.

Last updated: 2011-10-01

Index

A

Activating,

toolbars, 144

Adding,

commands, 143
search paths, 13
user-defined tools, 146

Aligning,

bottom edges, 138
file boxes on grid, 80
files in designs, 120
horizontal centers, 138
left edges, 138
MFD file boxes, 120
MFD file boxes on grid, 136
right edges, 138
schema boxes, 120
schema boxes on grid, 136
top edges, 138
vertical centers, 138

Arranging,

file boxes in designs, 87
windows, 71

Arranging windows,

cascade, 158
tile horizontally, 158
tile vertically, 158

Assigning,

hotkeys, 147
keyboard shortcuts, 147
shortcuts, 147

C

Changing,

appearance of menus, 149
focus, 110
order of file boxes, 120
order of MFD file boxes, 120

order of related XSLTs, 97
order of schema boxes, 120
toolbar name, 144

Changing the order,

bring to bottom, 139
bring to top, 139

Checking,

for Updates, 160

Closing,

active window, 132
context menu window, 149
designs, 82
SAD files, 82

Component origin,

displaying, 101
showing, 101
viewing, 101

Component usage,

displaying, 101
showing, 101
viewing, 101

Configuration file,

location, 17
viewing, 17

Configuring,

file extensions, 15
logging options, 58, 60
SchemaAgent Server GUI, 58
search paths, 12

Connecting,

to a server, 73
to LocalServer, 73
to SchemaAgent Server, 74
to server, 141
XMLSpy (tutorial), 29

Contacting,

Altova support center, 61, 160

Context options,

Design window, 116
Explorer, 75
for connectors, 124

Copying,

selection, 110, 133

Copyright information, 166

Correcting,

all reference paths, 142
incorrect paths, 114
reference paths, 114, 142

Creating,

- designs, 82
- directories, 76
- files, 76
- folders, 76
- IIR relationships, 128
- IIRs (tutorial), 25
- imports (tutorial), 27
- includes (tutorial), 25
- MapForce design files, 76
- MFD files, 76
- new design, 131
- redefines (tutorial), 26
- relations, 128
- relationships (tutorial), 25
- SAD files, 82
- schemas, 76
- toolbars, 144

Creating IIR relationships,

- imports (tutorial), 27
- includes (tutorial), 25
- redefines (tutorial), 26
- tutorial, 25

Customizing,

- commands, 143
- context menus, 149
- Default menu, 149
- keyboard, 147
- menu, 149
- options, 151
- SchemaAgent Client, 143
- SchemaAgent Design menu, 149
- shortcuts, 147
- toolbars, 144, 151
- tools, 146

Cutting,

- selection, 133

D**De-assigning,**

- hotkeys, 147
- keyboard shortcuts, 147
- shortcuts, 147

Deleting,

- commands from context menus, 149

- commands from menus, 149
- connector line, 124
- directories, 78
- files, 78
- files from designs, 112
- folders, 78
- IIR relation, 124
- IIR relationships, 129
- MapForce design files, 78
- MapForce design files from designs, 112
- MFD files, 78
- MFD files from designs, 112
- relations, 129
- relationship, 124
- schemas, 78
- schemas from designs, 112
- selection, 133
- toolbar, 144

Design window, 69

- aligning file boxes, 120
- aligning MFD file boxes, 120
- aligning schema boxes, 120
- arranging file boxes, 87
- changing order of file boxes, 120
- changing order of MFD file boxes, 120
- changing order of schema boxes, 120
- context options, 116
- deleting file boxes, 112
- deleting files, 112
- deleting MapForce design files, 112
- deleting MFD file boxes, 112
- deleting MFD files, 112
- deleting schema boxes, 112
- deleting schemas, 112
- force-directed, 120
- hierachical, 120
- inserting files, 82
- inserting folder content, 82
- inserting MapForce design files, 82
- inserting MFD files, 82
- inserting schemas, 82
- Layout, 120
- lining up file boxes, 120
- lining up MFD file boxes, 120
- lining up schema boxes, 120
- navigating, 87
- opening (tutorial), 25
- options, 116

Design window, 69

- removing file boxes, 112
- removing files, 112
- removing MapForce design files, 112
- removing MFD file boxes, 112
- removing MFD files, 112
- removing schema boxes, 112
- removing schemas, 112
- resizing file boxes, 120
- resizing MFD file boxes, 120
- resizing schema boxes, 120
- viewing files, 80
- viewing MapForce design files, 80
- viewing MFD files, 80
- viewing schemas, 80
- zooming in and out, 80

Designing,

- IIR relationships, 128
- relations, 128

Designs,

- closing, 82
- creating, 82
- exporting as images, 127
- opening, 82
- printing, 125
- saving, 82

Directories,

- creating, 76
- deleting, 78
- renaming, 78

Displaying,

- component origin, 101
- component usage, 101
- currently open windows, 158
- grid, 136
- IIR relationships, 93
- MapForce design files, 103
- MapForce Design relations, 99
- MFD file relations, 99
- MFD files, 103
- Quick information, 105
- related components, 101
- relation path, 124
- relations, 93
- schema relations, 96
- schemas (tutorial), 25
- stylesheet relations, 97
- WSDL relations, 98

XML instance relations, 96

XML schema relations, 96

XSLT relations, 97

Distribution,

- of Altova's software products, 166, 167, 169

Documentation,

- overview, 6

Downloading,

- components, 160
- free tools, 160

E

Editing,

- files, 79
- MapForce design files, 79
- MFD files, 79
- schemas, 79
- search paths, 13

End User License Agreement, 166, 170**Environment window,**

- Clients tab, 55
- Configure Paths tab (SchemaAgent Server), 55

Evaluation period,

- of Altova's software products, 166, 167, 169

Exiting, 132

- SchemaAgent Server, 54, 60

Explorer window,

- context options, 75
- creating directory, 76
- creating new file, 76
- Flat tab, 67
- Hierarchical tab, 67
- options, 75

Exporting,

- design fo image, 132
- designs as images, 127

F

FAQs, 61, 160**File boxes,**

- aligning on grid, 80
- arranging, 87

File boxes,

- sorting by name, 124
- sorting by width, 124

File extensions,

- considered in search paths, 15

Files,

- aligning, 120
- creating, 76
- deleting, 78
- reloading, 116
- renaming, 78

Focus,

- changing, 110
- setting, 110

Folders,

- creating, 76
- deleting, 78
- renaming, 78

G**Getting help,**

- Index tab, 61, 159
- Search tab, 61, 159
- Table of Contents tab, 61, 159

Ghost schemas,

- definition, 112
- recreating, 116, 133

Graphical user interface,

- Design window (SchemaAgent Client), 69
- Environment window (SchemaAgent Server), 55
- Explorer (SchemaAgent Client), 67
- Log window (SchemaAgent Server), 56
- Menu bar (SchemaAgent Client), 70
- Overview window (SchemaAgent Client), 69
- SchemaAgent Client, 67
- SchemaAgent Server, 55
- Toolbar (SchemaAgent Client), 70

Grid,

- aligning MFD boxes, 136
- aligning schema boxes, 136
- displaying, 136
- hiding, 80
- showing, 80, 136
- viewing, 136

GUI,

- Design window (SchemaAgent Client), 69
- Environment window (SchemaAgent Server), 55
- Explorer (SchemaAgent Client), 67
- Log window (SchemaAgent Server), 56
- Menu bar (SchemaAgent Client), 70
- Overview window (SchemaAgent Client), 69
- SchemaAgent Client, 67
- SchemaAgent Server, 55
- Toolbar (SchemaAgent Client), 70

H**Hiding,**

- grid, 80
- SchemaAgent Server, 54

Highlighting,

- component relations, 93
- connector lines, 93
- IIR relationships, 93
- relations, 93

Hotkeys,

- assigning, 147
- de-assigning, 147
- resetting all, 147

I**IIR relationships,**

- creating, 128
- deleting, 129
- designing, 128
- displaying, 93
- moving, 129
- viewing, 93
- viewing updates (tutorial), 42

Importing,

- types using XMLSpy (tutorial), 37

Including,

- types using only XMLSpy (tutorial), 39
- types using XMLSpy (tutorial), 30

Incorrect paths, 112**Inserting,**

- directly referenced files, 84
- files, 82

Inserting,

- folder content, 82
- linked files, 84
- MapForce design files, 82
- MFD files, 82
- referenced files, 84
- related files, 84
- related MapForce design files, 84
- related MFD files, 84
- related schemas, 84
- schemas, 82

Installing,

- SchemaAgent Client, 65
- SchemaAgent Server, 49
- SchemaAgent Server as interactive service, 51
- SchemaAgent Server as non-interactive service, 51
- SchemaAgent Server as standalone server, 50
- using command line, 49

Interactive Service, 51**Interface,**

- Design window (SchemaAgent Client), 69
- Environment window (SchemaAgent Server), 55
- Explorer (SchemaAgent Client), 67
- Log window (SchemaAgent Server), 56
- Menu bar (SchemaAgent Client), 70
- Overview window (SchemaAgent Client), 69
- SchemaAgent Client, 67
- SchemaAgent Server, 55
- Toolbar (SchemaAgent Client), 70

K**Keyboard shortcuts,**

- assigning, 147
- de-assigning, 147
- resetting all, 147

L**Legal information, 166****License, 170**

- information about, 166

License metering,

- in Altova products, 168

Lining up,

- horizontally, 139
- vertically, 139

Linked files, 86**LocalServer,**

- connecting to, 73

Log window, 56**M****MapForce design files,**

- creating, 76
- deleting, 78
- editing, 79
- inserting, 82
- Quick information, 105
- reloading, 116
- renaming, 78

MapForce Designs,

- displaying relations, 99
- toggleing input/output instances, 99
- viewing relations, 99

Menu,

- Align edges submenu, 138
- Edit, 132
- Extras, 141
- File, 60, 131
- Help, 60, 158
- Layout, 136
- Layout sub-menu, 137
- Line up sub-menu, 139
- Order sub-menu, 139
- Resize sub-menu, 139
- Select sub-menu, 134
- Settings, 60
- Sort sub-menu, 140
- Space Evenly sub-menu, 140
- Tools, 143
- View, 60, 135
- Window, 157
- Zoom sub-menu, 136

Menu bar,

- SchemaAgent Client, 70

MFD file,

- creating, 76

MFD file boxes,

MFD file boxes,

- aligning, 120
- aligning on grid, 80
- arranging, 87
- auto-sizing, 87
- changing order, 120
- collapsing structure, 87
- expanding structure, 87
- lining up, 120
- resizing, 120

MFD files,

- deleting, 78
- displaying relations, 99
- editing, 79
- inserting, 82
- Quick information, 105
- reloading, 116
- renaming, 78
- toggling input/output instances, 99
- viewing relations, 99

Moving,

- IIR relationships, 129
- relations, 129

N**Navigating,**

- within Design window, 87

Non-interactive Service, 51**O****Opening,**

- design files, 131
- Design window (tutorial), 25
- designs, 82
- SAD files, 82, 131

Options,

- color, 155
- customizing, 151
- design, 152
- fonts, 154
- for connectors, 124
- logging, 60

miscellaneous, 157

relations, 156

Order,

- of related XSLTs, 97

Overview window, 69**P****Pasting,**

- content of clipboard, 133
- selection, 110

Previewing,

- active file, 132
- designs, 125

Printing,

- active file, 132
- designs, 125

Q**Quick information,**

- displaying, 105
- for component relations, 105
- for MapForce design files, 105
- for MFD files, 105
- for relations, 105
- for schemas, 105
- showing, 105
- viewing, 105

R**Recreating,**

- ghost schemas, 116, 133

Redefining,

- types using XMLSpy (tutorial), 32

Reference paths,

- correcting, 142
- correcting all, 142

Referenced files,

- directly, 84
- indirectly, 85

Referencing files,

Referencing files,

- directly, 84
- indirectly, 85

Registration, 160**Related components,**

- displaying, 101
- showing, 101
- viewing, 101

Relations,

- designing, 128
- directly referenced, 84
- directly referencing, 84
- displaying, 93
- indirectly referenced, 85
- indirectly referencing, 85
- linked, 86
- MapForce Design relations, 99
- MFD file relations, 99
- schemas, 96
- showing, 93
- stylesheets, 97
- viewing, 93
- WSDL files, 98
- XML instances, 96
- XML schemas, 96
- XSLT stylesheets, 97

Relationships,

- creating (tutorial), 25
- imports (tutorial), 27
- includes (tutorial), 25
- redefines (tutorial), 26
- viewing updates (tutorial), 42

Reloading,

- files, 116
- MapForce design files, 116
- MFD files, 116
- schemas, 116
- search paths, 16, 141

Removing,

- file boxes, 112
- files, 112
- MapForce design files, 112
- MFD file boxes, 112
- MFD files, 112
- schema boxes, 112
- schemas, 112
- user defined-tools, 146

Renaming,

- directories, 78
- files, 78
- folders, 78
- MapForce design files, 78
- MFD files, 78
- schemas, 78
- toolbar, 144
- user-defined tools, 146

Resetting,

- all toolbars, 144
- context menus, 149
- hotkeys, 147
- keyboard shortcuts, 147
- menu bars, 149
- search paths, 16
- shortcuts, 147
- toolbars, 144

Resizing,

- file boxes, 120
- MFD file boxes, 120
- schema boxes, 120
- to same height, 139
- to same size, 139
- to same width, 139

S

SAD files,

- closing, 82
- creating, 82
- opening, 82
- saving, 82

Saving,

- contents of active window, 132
- design to image, 132
- designs, 82
- SAD files, 82
- to new file, 132

Schema,

- creating, 76
- recreating ghost schemas, 133

Schema boxes,

- aligning, 120
- aligning on grid, 80
- arranging, 87
- auto-sizing, 87

Schema boxes,

- changing order, 120
- collapsing structure, 87
- expanding structure, 87
- lining up, 120
- resizing, 120

SchemaAgent,

- Client documentation, 64
- Introduction, 8
- main features, 10
- SchemaAgent Server, 48
- tutorial, 20
- user manual, 3
- user reference, 131

SchemaAgent Client,

- connecting to a server, 73
- connecting to LocalServer, 73
- connecting to SchemaAgent Server, 74
- customizing, 143
- graphical user interface, 67
- GUI, 67
- installation, 65
- interface, 67
- overview, 64
- starting, 66
- user interface, 67

SchemaAgent Server,

- connecting to, 74
- exiting, 54, 60
- graphical user interface, 55
- GUI, 55
- hiding, 54
- interface, 55
- overview, 48
- showing, 54
- shutting down, 60
- starting, 53
- user interface, 55

Schemas,

- deleting, 78
- displaying (tutorial), 25
- displaying relations, 96
- editing, 79
- ghost schemas, 112
- inserting, 82
- Quick information, 105
- reloading, 116
- renaming, 78

- selecting, 134
- unknown schemas, 78
- viewing, 88
- viewing relations, 96

Search paths,

- adding, 13
- configuring, 12
- editing, 13
- reloading, 16, 141
- resetting, 16
- tutorial, 22

Selecting,

- component relations, 93
- connector lines, 93
- files, 110
- IIR relationships, 93
- MapForce design files, 110
- MFD files, 110
- multiple files, 110
- related files, 110
- relations, 93
- schemas, 110, 134
- source, 124
- target, 124

Selection,

- copying, 110, 133
- cutting, 133
- deleting, 133
- pasting, 110
- synchronizing, 110, 133

Server,

- connecting to, 73
- interactive service, 51
- network server, 74
- non-interactive service, 51
- SchemaAgent Server, 74
- standalone, 50
- working locally, 73

Service,

- interactive, 51
- non-interactive, 51

Setting up SchemaAgent Client, 21**Setup, 21****Shortcuts,**

- assigning, 147
- de-assigning, 147
- resetting all, 147

Showing,

Showing,

- component origin, 101
- component usage, 101
- currently open windows, 158
- grid, 80, 136
- IIR relationships, 93
- MapForce design files, 103
- MFD files, 103
- Quick information, 105
- related components, 101
- relation path, 124
- relations, 93
- SchemaAgent Server, 54

Shutting down,

- SchemaAgent Server, 60

Software Activation, 159**Software product license, 170****Sorting,**

- ascending, 140
- by name, 124, 140
- by width, 124, 140
- descending, 140
- file boxes, 124

Spacing,

- horizontally even, 140
- vertically even, 140

Standalone server, 50**Starting,**

- SchemaAgent Client, 66
- SchemaAgent Server, 53

Status bar,

- tooggling on and off, 135

Stylesheets,

- displaying relations, 97
- viewing relations, 97

Synchronizing,

- selection, 133

Synchronizing selections, 110**T****Tooggling,**

- status bar, 135
- toolbars, 60, 135

Toolbar,

- activating, 144

creating, 144

customizing, 144

deleting, 144

renaming, 144

resetting, 144

SchemaAgent Client, 70

Toolbars,

tooggling on and off, 60, 135

Tools,

adding user-defined, 146

changing the sequence, 146

customizing, 146

removing user-defined, 146

renaming user-defined, 146

Tutorial,

configuration, 20

configuring a search path, 22

connecting to a server, 21

connecting XMLSpy, 29

creating IIR relationships, 25

creating imports, 27

creating includes, 25

creating redefines, 26

displaying schemas, 25

example files, 20

importing types, 37

including types, 30

including types using only XMLSpy, 39

installation, 20

license, 20

making elements global, 30

opening a Design window, 25

overview, 20

redefining types, 32

search paths, 22

set up, 21

starting SchemaAgent Client, 21

using redefined types, 35

using XMLSpy as client, 29

viewing MapForce design files, 44

viewing MFD files, 44

viewing updated relationships, 42

U**Unknown schema, 78**

User interface,

- Design window (SchemaAgent Client), 69
- Environment window (SchemaAgent Server), 55
- Explorer (SchemaAgent Client), 67
- Log window (SchemaAgent Server), 56
- Menu bar (SchemaAgent Client), 70
- Overview window (SchemaAgent Client), 69
- SchemaAgent Client, 67
- SchemaAgent Server, 55
- Toolbar (SchemaAgent Client), 70

User reference,

- SchemaAgent Client, 131
- SchemaAgent Server, 60

V**Viewing,**

- component origin, 101
- component usage, 101
- configuration file, 17
- currently open windows, 158
- design files (tutorial), 44
- files, 80
- grid, 136
- IIR relationships, 93
- MapForce design files, 80, 103
- MapForce design files (tutorial), 44
- MapForce Design relations, 99
- MFD file relations, 99
- MFD files, 80, 103
- MFD files (tutorial), 44
- Quick information, 105
- related component, 101
- relation path, 124
- relations, 93
- schema relations, 96
- schemas, 80, 88
- stylesheet relations, 97
- updated relationships (tutorial), 42
- WSDL relations, 98
- XML instance relations, 96
- XML schema relations, 96
- XSLT stylesheet relations, 97

W**WDSL files,**

- displaying relations, 98
- viewing relations, 98

Windows,

- arranging, 71
- Design, 69
- Environment, 55
- Explorer, 67
- Log, 56
- Overview, 69

X**XML instances,**

- displaying relations, 96
- toggleing input/output in MFDs, 99
- viewing relations, 96

XMLSpy,

- as a SchemaAgent client, 164
- as client (tutorial), 29
- connecting (tutorial), 29

XSLT stylesheets,

- changing order, 97
- displaying relations, 97
- viewing relations, 97

Z**Zooming, 80, 136**